

CBN Grade for Turning Hardened Steel

BC8200 Series

Breaker
Expansion

New Coated CBN Grades for the Modern Methods of Turning Hardened Steels

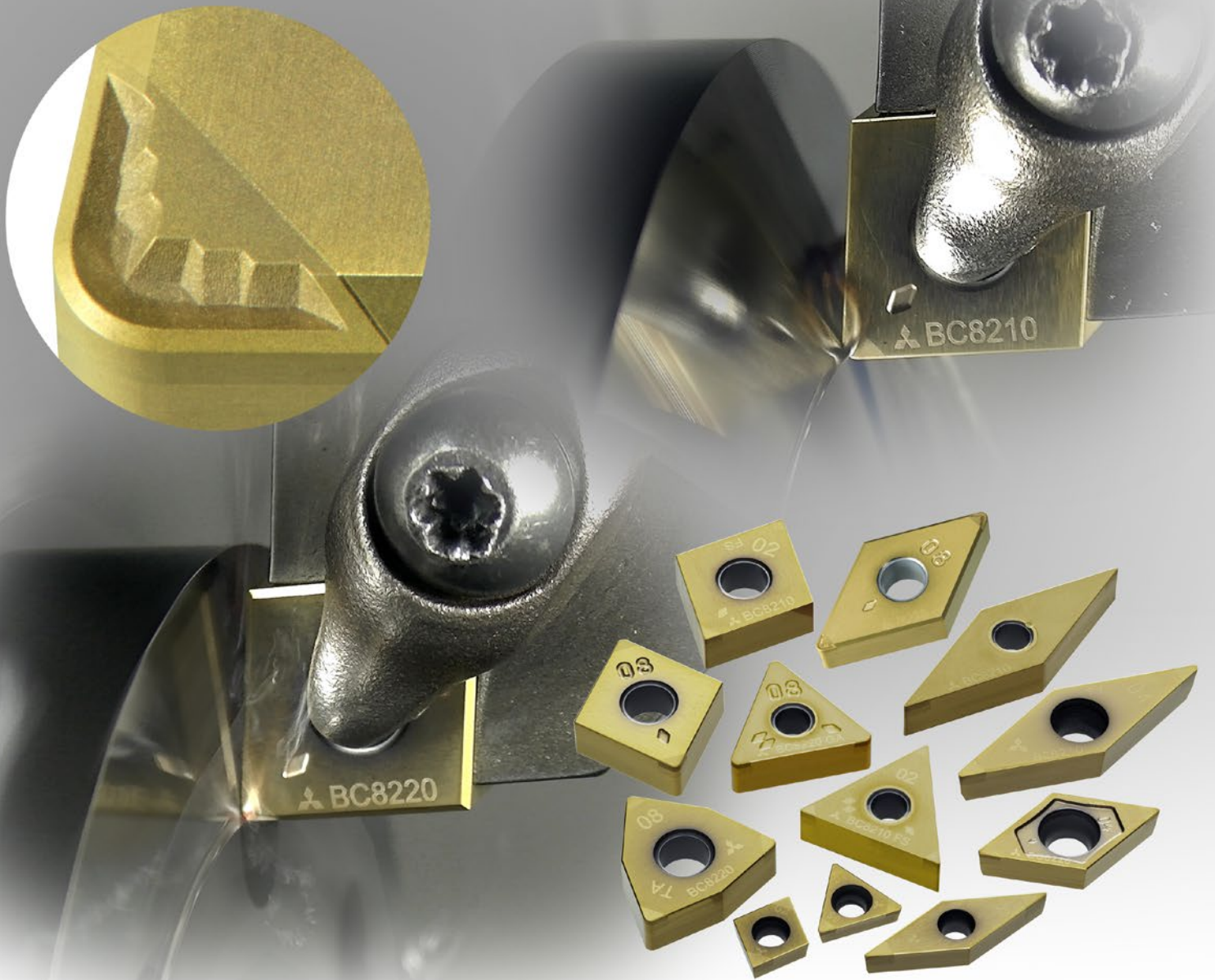

CBN Grade for Turning Hardened Steel

BC8200 Series

NEW

BC8210 For Continuous and Light Interrupted Cutting

Outstanding Tool Life with High-speed Machining

Suitable for continuous cutting and light interrupted cutting. BC8210 exhibits excellent chipping, flank and crater wear resistance, thereby providing a stable machining process for high cutting conditions.

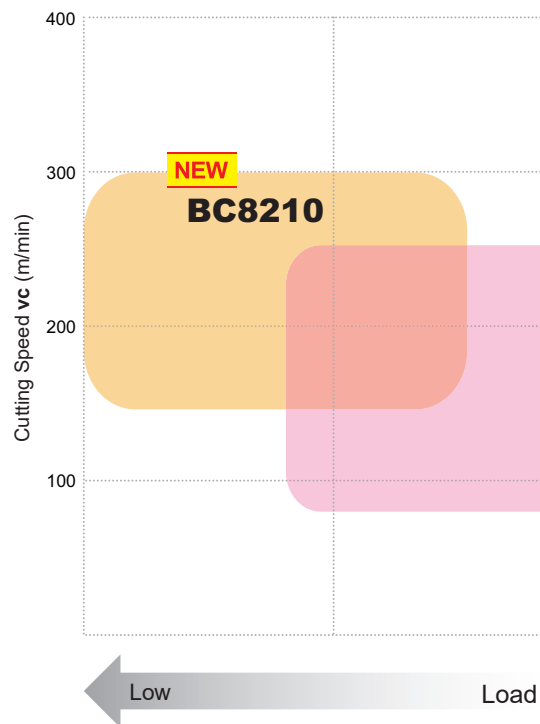
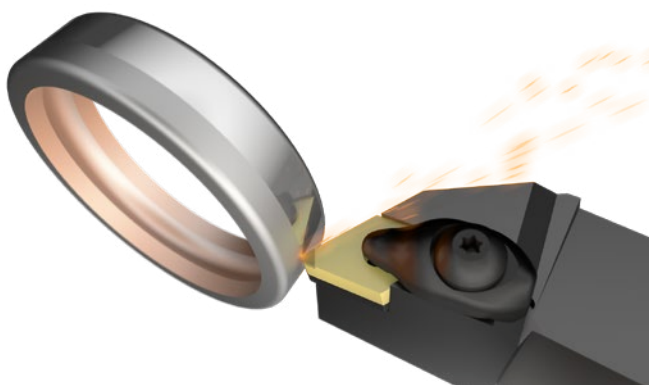

Comparison of Wear Resistance During Continuous Cutting

Defects due to crater wear are suppressed and tool life is improved compared to conventional products.

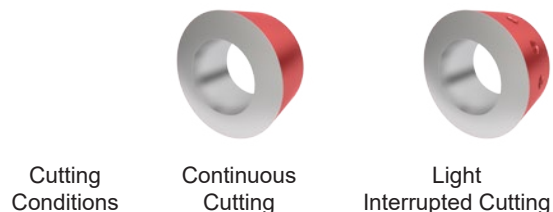
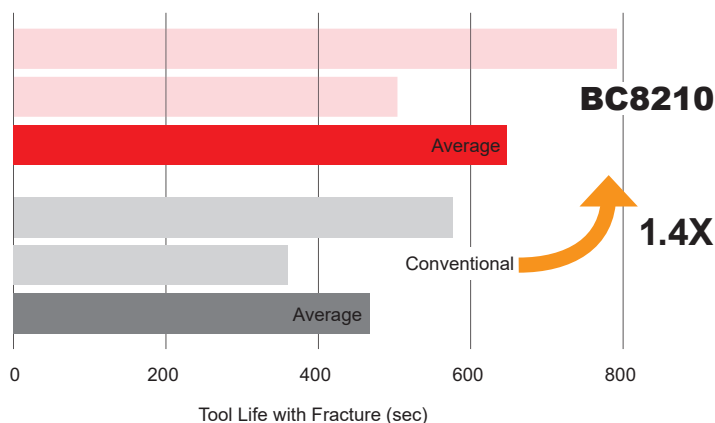

<Cutting Conditions>
 Workpieces Material : JIS SCr420 (60 HRC)
 Inserts : NP-CNGA120408GS2
 Cutting Speed : $vc=200\text{m/min}$
 Feed per Rev. : $f=0.1\text{mm/rev}$
 Depth of Cut : $ap=0.2\text{mm}$
 Cutting Mode : Dry Cutting

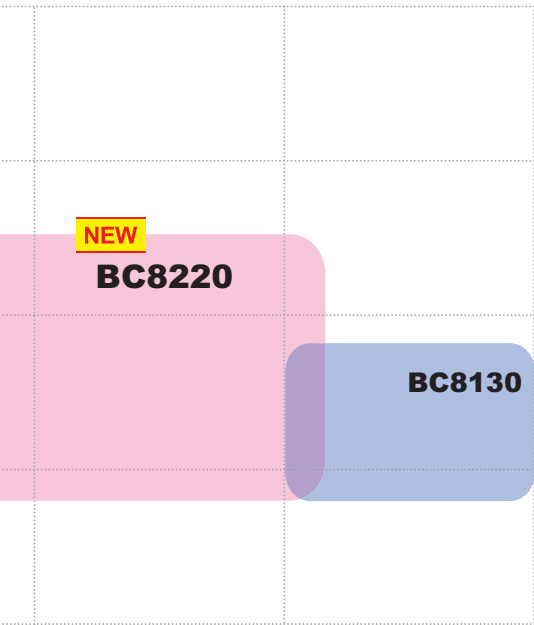

NEW

BC8220

BC8130

Conditions → High



Medium Interrupted Cutting



Heavy Interrupted Cutting

<Cutting Conditions>

Workpieces Material : JIS SCr420 (60 HRC)
 Inserts : NP-CNGA120408VA2
 Cutting Speed : $v_c=250$ m/min
 Feed per Rev. : $f=0.15$ mm/rev
 Depth of Cut : $a_p=0.1$ mm
 Cutting Mode : Dry Cutting

NEW

BC8220 General Applications

Achieves Impressive Tool Life Over a Wide Range of Cutting Conditions.

Highly suited to a wide application area from continuous through to heavy interrupted cutting. It also has excellent crater wear and fracture resistance due to the new CBN base material and together with a new coating, dramatically extends tool life.

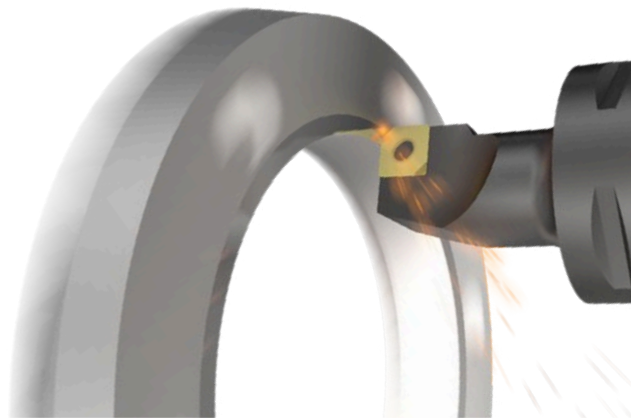

Comparison of Fracture Resistance During Medium Interrupted Cutting

Excelling in suppressing chipping and cracks, it also improves fracture resistance after crater wear and provides a stable cutting action that improves tool life.

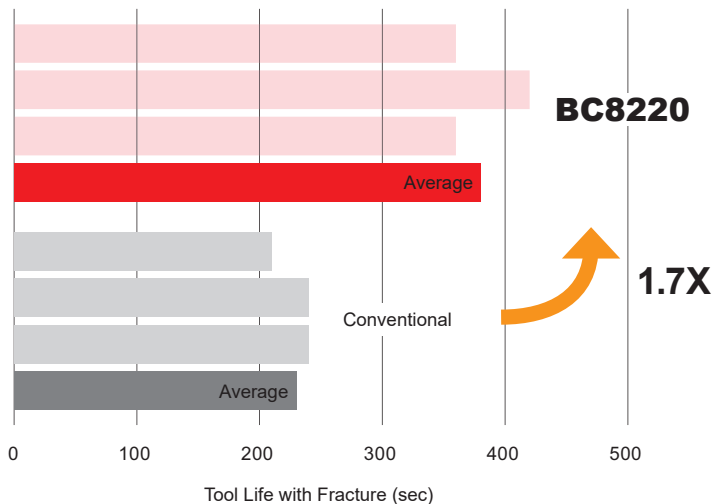

Features

BC8210

The combination of the newly developed AlCrSiN-base coating, that absorbs impacts and the TiAlSiN-base coating, which has excellent wear resistance, provide stable wear resistance in continuous through to low interrupted cutting.

NEW

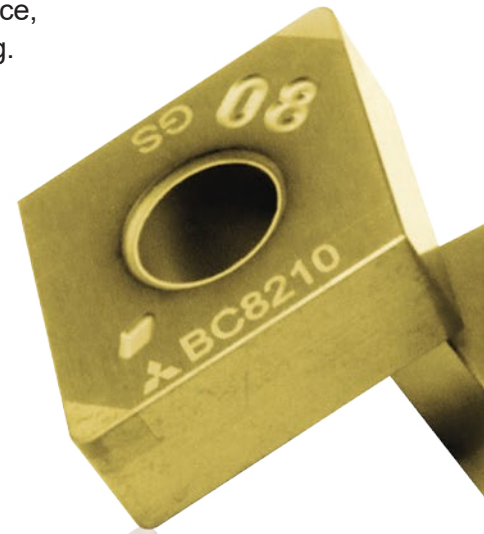
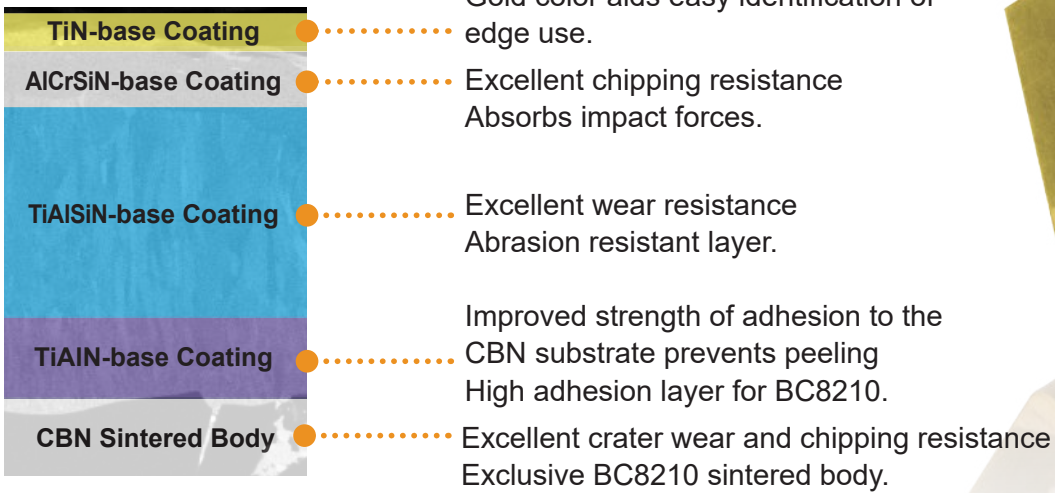

Ultra Micro-particle/ Heat Resistant Binder Technology

The new CBN substrate contains a new ultra micro-particle and heat resistant binder. This suppresses both chipping and crater wear that promotes longer tool life.

Optimised Substrate Technology with Ultra Micro-particle Binder

The ultra micro-particle binder prevents linear crack development to avoid sudden fracturing.

Conventional

Cutting Resistance

Forces Dispersed in a Linear Pattern

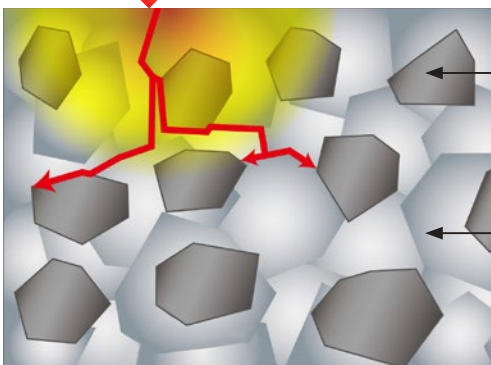

BC8200, BC8100 Series

Cutting Resistance

Forces Dispersed Radially

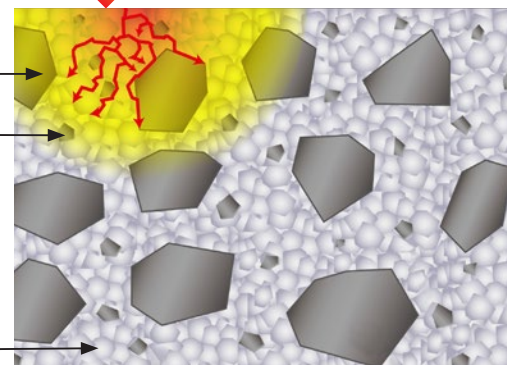

Medium Grain cBN

Micro Grain cBN

Binder Macroparticles

Ultra Micro-particle Binder

BC8220

TiAlN-base coating, which has excellent wear resistance and a fine multi-layered structure suppresses the growth of cracks in the coating and thereby reduces edge chipping. This allows for stable cutting over a wide variety of applications.

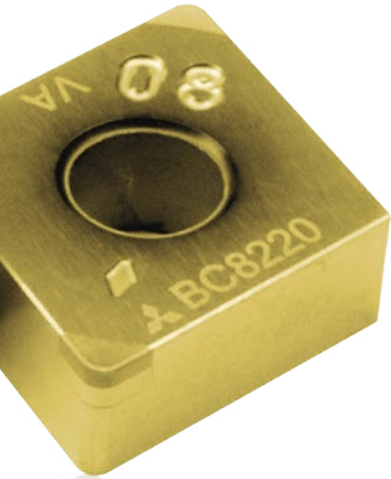

NEW

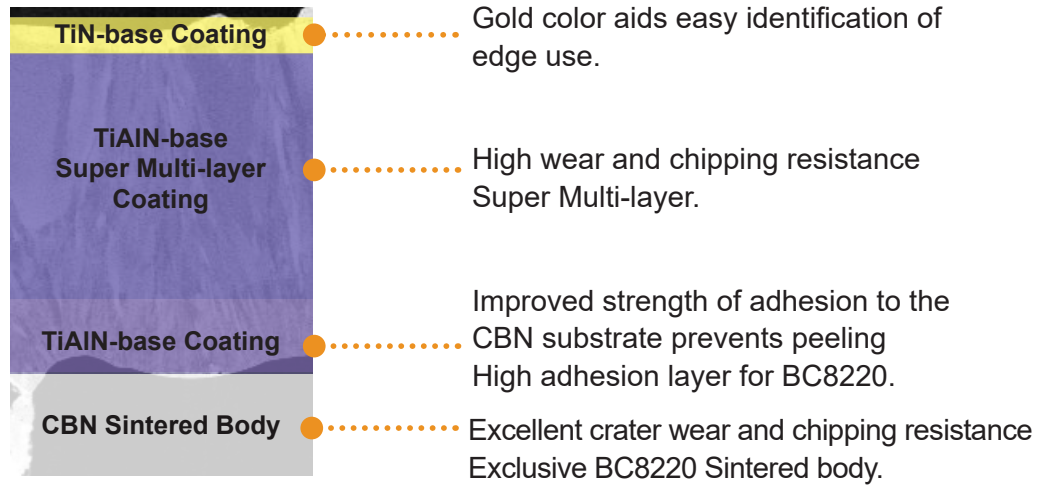

NEW

Positive Effect of the Newly Developed Heat Resistant Binder

By increasing the heat resistance of the binder, wear resistance due to the deterioration of the binder component is increased, thereby suppressing crater wear, chipping and fracturing.

Conventional

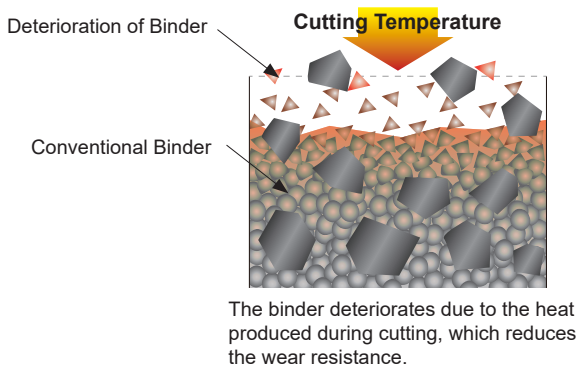

BC8200 Series

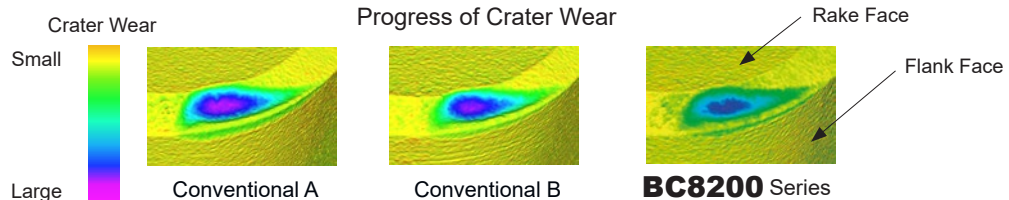
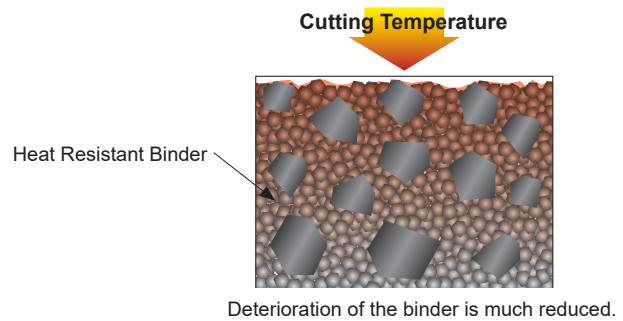

Features of the Insert

Chip Breaker

A BR breaker has been added to achieve better chip control at higher depths of cut. A versatile range of chip breakers are available for a wide range of applications.

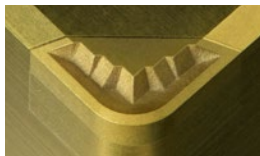

BR Breaker



BM Breaker



BF Breaker

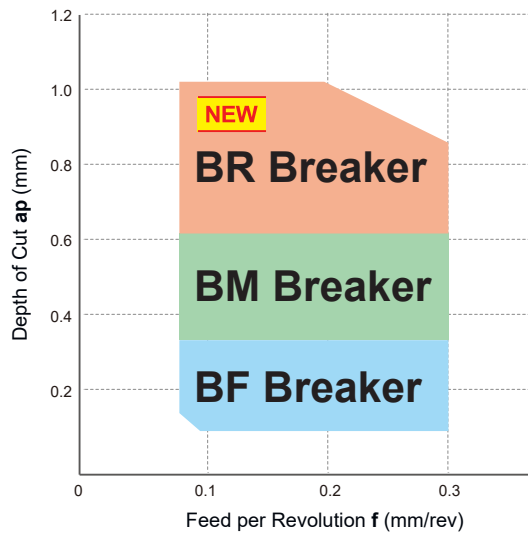

BR Breaker (BC8220) NEW

A reduced number of passes needed and improved chip control during high depth of cut. Chips are formed with the effect from the rake angle, and the multi stage breaker wall supports a wide range of cuts.

Recommended Cutting Conditions : $vc=80-200$ m/min, $f \leq 0.3$ mm/rev, $a_p=0.6-1.0$ mm

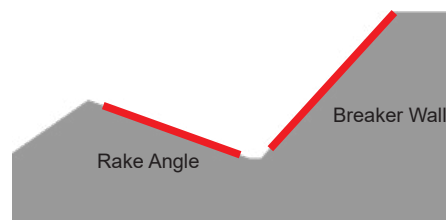
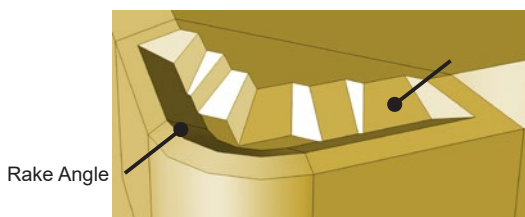

Achieves ideal chip control even at high depths of cut.

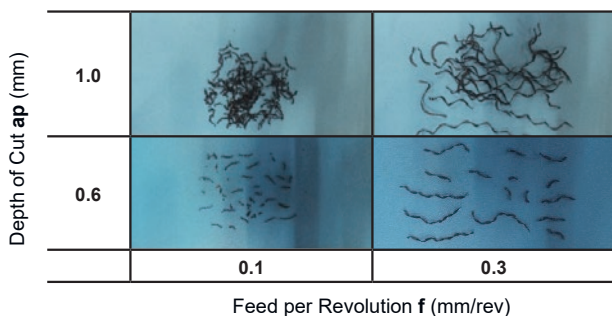

<Cutting Conditions>
 Workpiece Material : JIS SCr420 (60 HRC)
 Inserts : BR-CNGM120408TA2
 Cutting Speed : $vc=200$ m/min
 Feed per Rev. : $f=0.1$ mm/rev
 0.3 mm/rev
 Depth of Cut : $a_p=0.6$ mm
 1.0 mm
 Cutting Mode : Dry Cutting

BM Breaker (BC8220)

Great chip control when machining at medium depths of cut. (0.3-0.8 mm)

Recommended Cutting Conditions : $vc=80-200$ m/min, $f \leq 0.3$ mm/rev, $ap=0.3-0.8$ mm

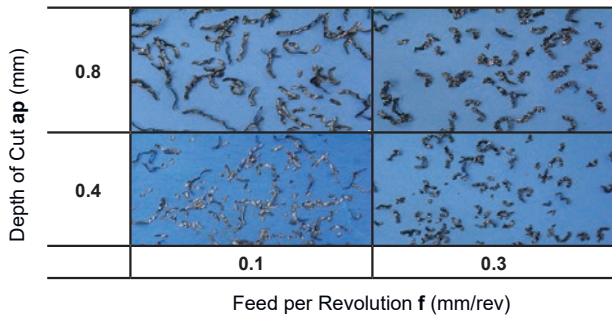
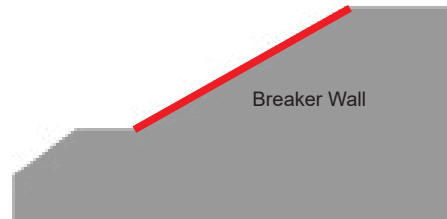
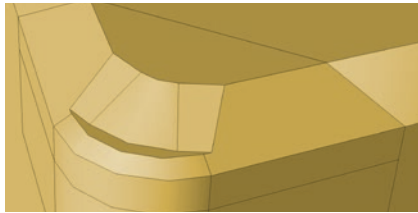

<Cutting Conditions>
 Workpiece Material : JIS SCM415 (60 HRC)
 Inserts : BM-CNGM120408TA2
 Cutting Speed : $vc=160$ m/min
 Feed per Rev. : $f=0.1$ mm/rev
 : 0.3 mm/rev
 Depth of Cut : $ap=0.4$ mm
 : 0.8 mm
 Cutting Mode : Dry Cutting

BF Breaker (BC8210, BC8220)

Achieves excellent chip control while finish cutting at depths of 0.3 mm or less.

Recommended Cutting Conditions : $vc=80-200$ m/min, $f \leq 0.3$ mm/rev, $ap=0.1-0.3$ mm

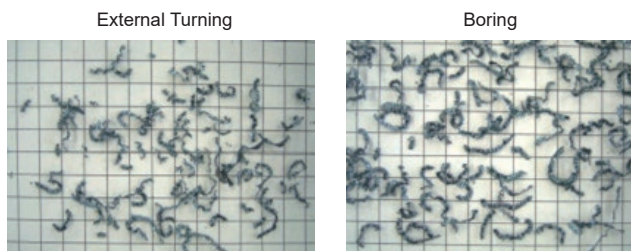
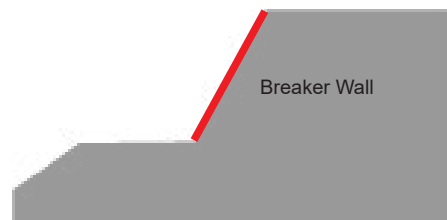
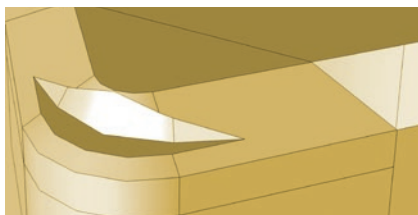

Cutting Speed : $vc=100$ m/min
 Feed per Rev. : $f=0.2$ mm/rev
 Depth of Cut : $ap=0.3$ mm

Cutting Speed : $vc=120$ m/min
 Feed per Rev. : $f=0.2$ mm/rev
 Depth of Cut : $ap=0.3$ mm

<Cutting Conditions>
 Workpiece Material : JIS SCM415 (60 HRC)
 Inserts : BF-CNGM120408TS2
 Cutting Mode : Dry Cutting

Wiper Insert

■ Features

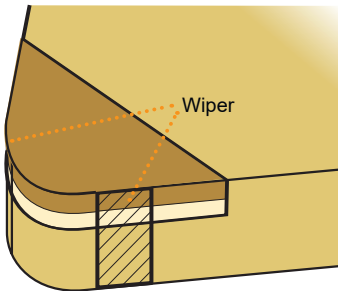

Improving Surface Finish

Under the same machining conditions as conventional chip breakers, but with the feed rate increased, the surface finish of the workpiece can be improved.

Improving Efficiency

High feed rates not only shorten machining times but also make it possible to combine roughing and finishing operations.

Increased Tool Life

When using at high feed conditions, the time required to cut one component is decreased, thus more parts can be machined with each insert. In addition, the high feed rate prevents rubbing, thereby, delaying the progression of wear and increasing tool life.

Improving Chip Control

Under high feed conditions, the chips generated become thicker and are more easily broken, thus, chip control is improved.

■ Recommended Cutting Conditions and Performance

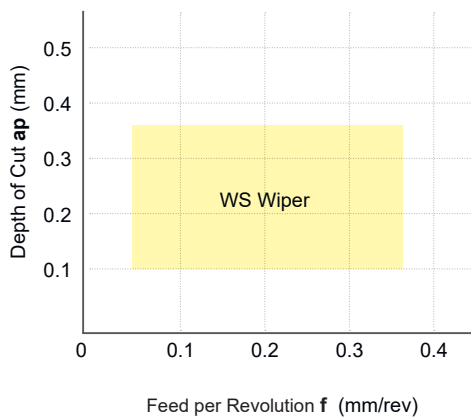

Cutting Speed: $v_c=150\text{m/min}$ Feed per Rev.: $f=0.3\text{mm/rev}$
 Depth of Cut: $a_p=0.1\text{mm}$ Cutting Mode: Dry Cutting

Without Wiper

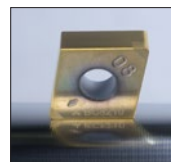

$R_z=6.9\mu\text{m}$

With Wiper

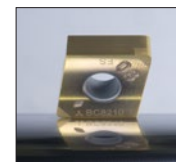

$R_z=1.2\mu\text{m}$

■ Cutting Performance



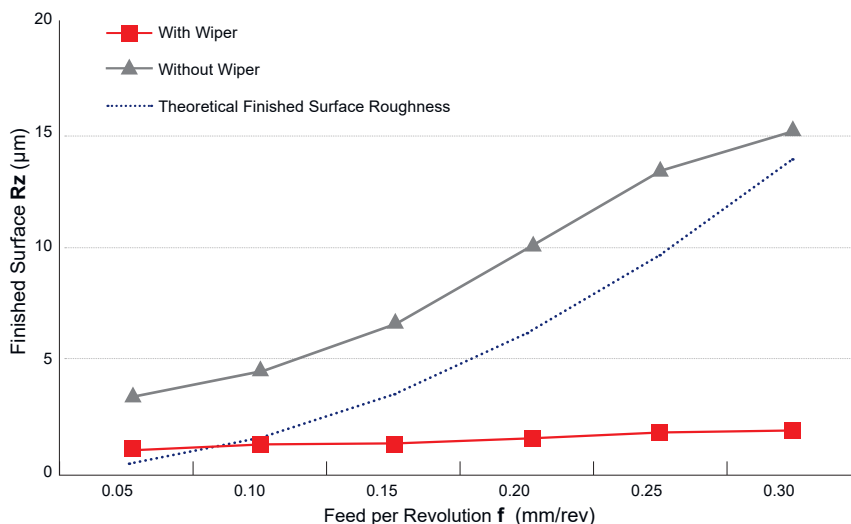

WL Wiper (External Turning)



<Cutting Conditions>

Workpiece Material : Hardened Steel (60HRC)
 Insert : NP-CNGA120408
 Machining Methods : Continuous
 Cutting Speed : $v_c=120\text{m/min}$
 Depth of Cut : $a_p=0.1\text{mm}$
 Cutting Mode : Dry Cutting

Combination of BF Breaker and WS Wiper Insert

CNGM and DNGM types are now available with new inserts that combine a BF chip breaker with a WS wiper Insert. (BC8210 : BF-CNGMTSWS2, BC8220 : BF-DNGMTAWS2)
It is effective for chip control and improvement of finished surface roughness without concerns about the hand of the tool even when continuous external or internal turning and facing.

BF Breaker

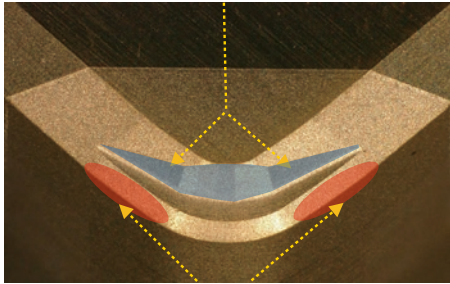

WS Wiper Insert (Neutral)
BF-CNGM120408TSWS2

BF Breaker

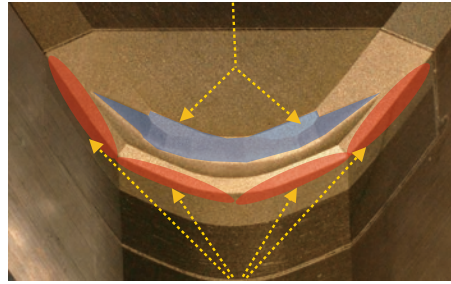

WS Wiper Insert (Neutral)
BF-DNGM150412TAWS2

Notes for Use

When using CNGM type

No Restriction for Holders

A standard holder can be used.
(*A double clamp, high rigidity tool is recommended.)

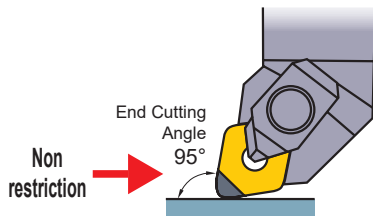

When using DNGM type

Restriction for Holders

Use PDJN holder or DDJN holder with an end cutting angle 93° for improving wiper efficiency. There is no wiper efficiency with other end cutting angles (60°, 90°, 107° etc.).

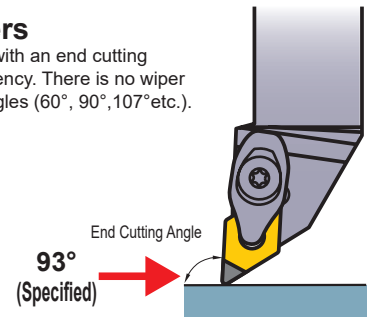

Displays great wiper efficiency when machining the end face and outer diameter in both right-hand and left-hand machining.

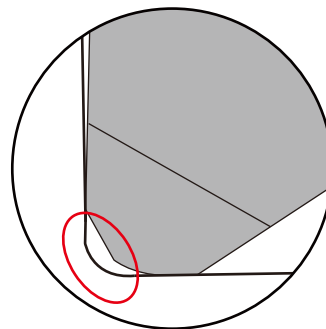
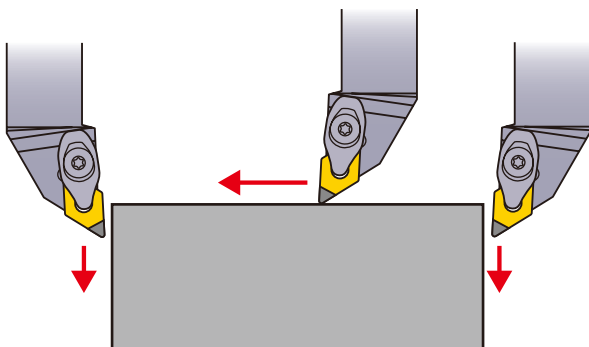

*The DNGM type is not suitable for machining the R that connects the end face and the outer diameter because it will leave uncut parts.

Features of the Insert

Edge Preparation (Honing)

New VA honing type with improved fracture resistance for high speeds and feeds. In addition, a range of different honing types for a wide range of applications is available.

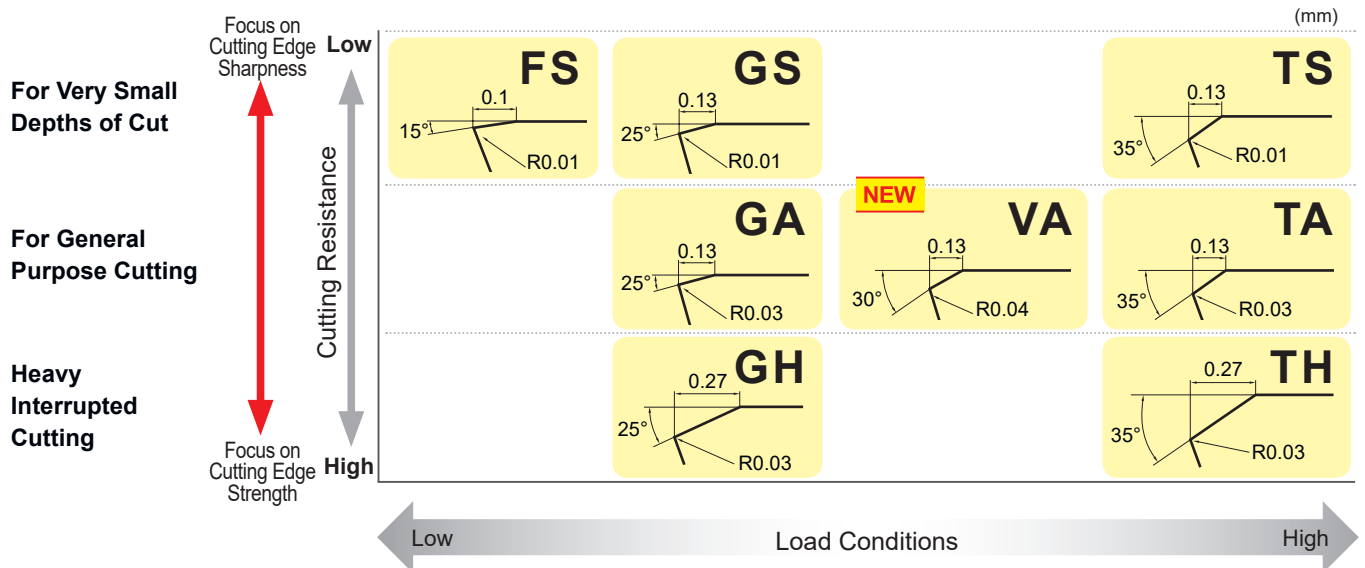

	Continuous Cutting	General Purpose		For Fracture Resistance	Interrupted Cutting	
	General Cutting	General Cutting	High Feed and Depth	High Speeds and Feed	General Cutting	High Feed and Depth
BC8210	FS	GS	GH		TS	
BC8220		GA	GH	VA	TA	TH

Identification

BF -CNGM120408 **TA** **WS** 2 **--**

Insert Geometry	
BR	For High Depth of Cut Chip Breaker
BM	For Medium Depth of Cut Chip Breaker
BF	For Finish Cutting Chip Breaker
NP	New Petit Cut

Edge Preparation	
Symbol	Application
FS	Continuous Cutting
GS GA GH	General Cutting
VA	For High Speed, High Feed Cutting
TS TA TH	Interrupted Cutting

Wiper	
WS	For High Rigidity Workpiece Material
No Mark	Without Wiper

Cutting Direction		
Symbol	Hand	Figure
JR	Right	
JL	Left	
No mark	Neutral	

Memo

A series of horizontal dashed lines for writing, spanning the width of the page.







BC8200 Series

NEW

Negative Inserts (With Hole)

G Class

CNGA, CNGM

NEW PETIT CUT	NEW PETIT CUT	NEW PETIT CUT	NEW PETIT CUT
NP_004	NP_00WS4	NP_002	NP_00WS2
	 (With Wiper)		 (With Wiper)
NEW PETIT CUT	NEW PETIT CUT		
BF_ BM_	BR_		
 (With Breaker)	 (With Breaker)		

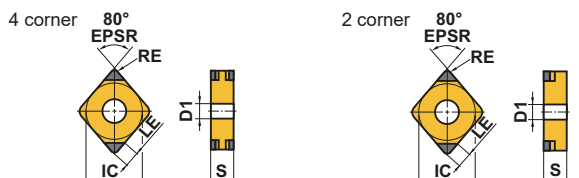

(mm)

Order Number	Coated CBN					Cutting Edges	IC	S	RE	D1	LE
	BC8210	BC8220									
NP-CNGA120404GA4		●				4	12.7	4.76	0.4	5.16	1.8
NP-CNGA120408GA4		●				4	12.7	4.76	0.8	5.16	2.0
NP-CNGA120412GA4		●				4	12.7	4.76	1.2	5.16	2.2
NP-CNGA120404GS4	●					4	12.7	4.76	0.4	5.16	1.8
NP-CNGA120408GS4	●					4	12.7	4.76	0.8	5.16	2.0
NP-CNGA120412GS4	●					4	12.7	4.76	1.2	5.16	2.2
NP-CNGA120404GH4	●	●				4	12.7	4.76	0.4	5.16	1.8
NP-CNGA120408GH4	●	●				4	12.7	4.76	0.8	5.16	2.0
NP-CNGA120412GH4	●	●				4	12.7	4.76	1.2	5.16	2.2
NP-CNGA120404FS4	●					4	12.7	4.76	0.4	5.16	1.8
NP-CNGA120408FS4	●					4	12.7	4.76	0.8	5.16	2.0
NP-CNGA120412FS4	●					4	12.7	4.76	1.2	5.16	2.2
NP-CNGA120404VA4		●				4	12.7	4.76	0.4	5.16	1.8
NP-CNGA120408VA4		●				4	12.7	4.76	0.8	5.16	2.0
NP-CNGA120412VA4		●				4	12.7	4.76	1.2	5.16	2.2
NP-CNGA120404TA4		●				4	12.7	4.76	0.4	5.16	1.8
NP-CNGA120408TA4		●				4	12.7	4.76	0.8	5.16	2.0
NP-CNGA120412TA4		●				4	12.7	4.76	1.2	5.16	2.2
NP-CNGA120404TS4	●					4	12.7	4.76	0.4	5.16	1.8
NP-CNGA120408TS4	●					4	12.7	4.76	0.8	5.16	2.0
NP-CNGA120412TS4	●					4	12.7	4.76	1.2	5.16	2.2
NP-CNGA120408TH4		●				4	12.7	4.76	0.8	5.16	2.0
NP-CNGA120412TH4		●				4	12.7	4.76	1.2	5.16	2.2
NP-CNGA120404FSWS4	●					4	12.7	4.76	0.4	5.16	1.8
NP-CNGA120408FSWS4	●					4	12.7	4.76	0.8	5.16	2.0
NP-CNGA120412FSWS4	●					4	12.7	4.76	1.2	5.16	2.2
NP-CNGA120404GAWS4		●				4	12.7	4.76	0.4	5.16	1.8
NP-CNGA120408GAWS4		●				4	12.7	4.76	0.8	5.16	2.0
NP-CNGA120412GAWS4		●				4	12.7	4.76	1.2	5.16	2.2
NP-CNGA120404GSWS4	●					4	12.7	4.76	0.4	5.16	1.8
NP-CNGA120408GSWS4	●					4	12.7	4.76	0.8	5.16	2.0
NP-CNGA120412GSWS4	●					4	12.7	4.76	1.2	5.16	2.2
NP-CNGA120402GA2		●				2	12.7	4.76	0.2	5.16	1.7
NP-CNGA120404GA2		●				2	12.7	4.76	0.4	5.16	1.8
NP-CNGA120408GA2		●				2	12.7	4.76	0.8	5.16	2.0
NP-CNGA120412GA2		●				2	12.7	4.76	1.2	5.16	2.2
NP-CNGA120402GS2	●					2	12.7	4.76	0.2	5.16	1.7
NP-CNGA120404GS2	●					2	12.7	4.76	0.4	5.16	1.8
NP-CNGA120408GS2	●					2	12.7	4.76	0.8	5.16	2.0
NP-CNGA120412GS2	●					2	12.7	4.76	1.2	5.16	2.2

● : Inventory maintained in Japan. (1 insert in one case)

(mm)

Order Number	Coated CBN					Cutting Edges	IC	S	RE	D1	LE
	BC8210	BC8220									
NP-CNGA120404GH2	●	●				2	12.7	4.76	0.4	5.16	1.8
NP-CNGA120408GH2	●	●				2	12.7	4.76	0.8	5.16	2.0
NP-CNGA120412GH2	●	●				2	12.7	4.76	1.2	5.16	2.2
NP-CNGA120402FS2	●					2	12.7	4.76	0.2	5.16	1.7
NP-CNGA120404FS2	●					2	12.7	4.76	0.4	5.16	1.8
NP-CNGA120408FS2	●					2	12.7	4.76	0.8	5.16	2.0
NP-CNGA120412FS2	●					2	12.7	4.76	1.2	5.16	2.2
NP-CNGA120404VA2		●				2	12.7	4.76	0.4	5.16	1.8
NP-CNGA120408VA2		●				2	12.7	4.76	0.8	5.16	2.0
NP-CNGA120412VA2		●				2	12.7	4.76	1.2	5.16	2.2
NP-CNGA120404TA2		●				2	12.7	4.76	0.4	5.16	1.8
NP-CNGA120408TA2		●				2	12.7	4.76	0.8	5.16	2.0
NP-CNGA120412TA2		●				2	12.7	4.76	1.2	5.16	2.2
NP-CNGA120404TS2	●					2	12.7	4.76	0.4	5.16	1.8
NP-CNGA120408TS2	●					2	12.7	4.76	0.8	5.16	2.0
NP-CNGA120412TS2	●					2	12.7	4.76	1.2	5.16	2.2
NP-CNGA120408TH2		●				2	12.7	4.76	0.8	5.16	2.0
NP-CNGA120412TH2		●				2	12.7	4.76	1.2	5.16	2.2
NP-CNGA120404FSWS2	●					2	12.7	4.76	0.4	5.16	1.8
NP-CNGA120408FSWS2	●					2	12.7	4.76	0.8	5.16	2.0
NP-CNGA120412FSWS2	●					2	12.7	4.76	1.2	5.16	2.2
NP-CNGA120404GAWS2		●				2	12.7	4.76	0.4	5.16	1.8
NP-CNGA120408GAWS2		●				2	12.7	4.76	0.8	5.16	2.0
NP-CNGA120412GAWS2		●				2	12.7	4.76	1.2	5.16	2.2
NP-CNGA120404GSWS2	●					2	12.7	4.76	0.4	5.16	1.8
NP-CNGA120408GSWS2	●					2	12.7	4.76	0.8	5.16	2.0
NP-CNGA120412GSWS2	●					2	12.7	4.76	1.2	5.16	2.2
BF-CNGM120408TAWS2		●				2	12.7	4.76	0.8	5.16	2.0
BF-CNGM120412TAWS2		●				2	12.7	4.76	1.2	5.16	2.2
BF-CNGM120404TS2	●					2	12.7	4.76	0.4	5.16	1.8
BF-CNGM120408TS2	●					2	12.7	4.76	0.8	5.16	2.0
BF-CNGM120412TS2	●					2	12.7	4.76	1.2	5.16	2.2
BF-CNGM120408TSWS2	●					2	12.7	4.76	0.8	5.16	2.0
BF-CNGM120412TSWS2	●					2	12.7	4.76	1.2	5.16	2.2
BM-CNGM120404TA2		●				2	12.7	4.76	0.4	5.16	1.8
BM-CNGM120408TA2		●				2	12.7	4.76	0.8	5.16	2.0
BM-CNGM120412TA2		●				2	12.7	4.76	1.2	5.16	2.2
NEW BR-CNGM120404TA2		●				2	12.7	4.76	0.4	5.16	1.8
NEW BR-CNGM120408TA2		●				2	12.7	4.76	0.8	5.16	2.0
NEW BR-CNGM120412TA2		●				2	12.7	4.76	1.2	5.16	2.2

BC8200 Series

NEW

Negative Inserts (With Hole)

G Class

DNGA, DNGM

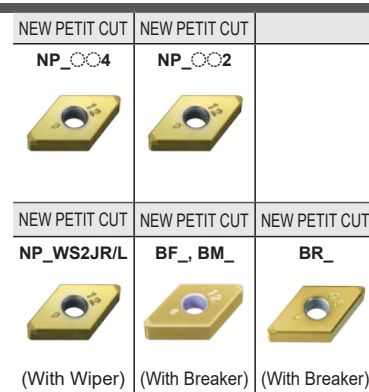
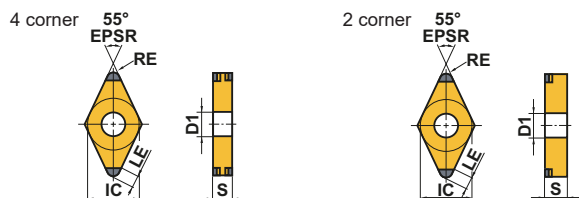

(mm)

Order Number	Coated CBN					Cutting Edges	IC	S	RE	D1	LE
	BC8210	BC8220									
NP-DNGA150404GA4	●					4	12.7	4.76	0.4	5.16	2.1
NP-DNGA150408GA4	●					4	12.7	4.76	0.8	5.16	2.0
NP-DNGA150412GA4	●					4	12.7	4.76	1.2	5.16	1.8
NP-DNGA150604GA4	●					4	12.7	6.35	0.4	5.16	2.1
NP-DNGA150608GA4	●					4	12.7	6.35	0.8	5.16	2.0
NP-DNGA150612GA4	●					4	12.7	6.35	1.2	5.16	1.8
NP-DNGA150404GS4	●					4	12.7	4.76	0.4	5.16	2.1
NP-DNGA150408GS4	●					4	12.7	4.76	0.8	5.16	2.0
NP-DNGA150412GS4	●					4	12.7	4.76	1.2	5.16	1.8
NP-DNGA150604GS4	●					4	12.7	6.35	0.4	5.16	2.1
NP-DNGA150608GS4	●					4	12.7	6.35	0.8	5.16	2.0
NP-DNGA150612GS4	●					4	12.7	6.35	1.2	5.16	1.8
NP-DNGA150404GH4	●	●				4	12.7	4.76	0.4	5.16	2.1
NP-DNGA150408GH4	●	●				4	12.7	4.76	0.8	5.16	2.0
NP-DNGA150412GH4	●	●				4	12.7	4.76	1.2	5.16	1.8
NP-DNGA150604GH4	●	●				4	12.7	6.35	0.4	5.16	2.1
NP-DNGA150608GH4	●	●				4	12.7	6.35	0.8	5.16	2.0
NP-DNGA150612GH4	●	●				4	12.7	6.35	1.2	5.16	1.8
NP-DNGA150404FS4	●					4	12.7	4.76	0.4	5.16	2.1
NP-DNGA150408FS4	●					4	12.7	4.76	0.8	5.16	2.0
NP-DNGA150412FS4	●					4	12.7	4.76	1.2	5.16	1.8
NP-DNGA150604FS4	●					4	12.7	6.35	0.4	5.16	2.1
NP-DNGA150608FS4	●					4	12.7	6.35	0.8	5.16	2.0
NP-DNGA150612FS4	●					4	12.7	6.35	1.2	5.16	1.8
NP-DNGA150404VA4	●					4	12.7	4.76	0.4	5.16	2.1
NP-DNGA150408VA4	●					4	12.7	4.76	0.8	5.16	2.0
NP-DNGA150412VA4	●					4	12.7	4.76	1.2	5.16	1.8
NP-DNGA150604VA4	●					4	12.7	6.35	0.4	5.16	2.1
NP-DNGA150608VA4	●					4	12.7	6.35	0.8	5.16	2.0
NP-DNGA150612VA4	●					4	12.7	6.35	1.2	5.16	1.8
NP-DNGA150404TA4	●					4	12.7	4.76	0.4	5.16	2.1
NP-DNGA150408TA4	●					4	12.7	4.76	0.8	5.16	2.0
NP-DNGA150412TA4	●					4	12.7	4.76	1.2	5.16	1.8
NP-DNGA150604TA4	●					4	12.7	6.35	0.4	5.16	2.1
NP-DNGA150608TA4	●					4	12.7	6.35	0.8	5.16	2.0
NP-DNGA150612TA4	●					4	12.7	6.35	1.2	5.16	1.8

● : Inventory maintained in Japan. (1 insert in one case)

(mm)

Order Number	Coated CBN					Cutting Edges	IC	S	RE	D1	LE
	BC8210	BC8220									
NP-DNGA150404TS4	●					4	12.7	4.76	0.4	5.16	2.1
NP-DNGA150408TS4	●					4	12.7	4.76	0.8	5.16	2.0
NP-DNGA150412TS4	●					4	12.7	4.76	1.2	5.16	1.8
NP-DNGA150604TS4	●					4	12.7	6.35	0.4	5.16	2.1
NP-DNGA150608TS4	●					4	12.7	6.35	0.8	5.16	2.0
NP-DNGA150612TS4	●					4	12.7	6.35	1.2	5.16	1.8
NP-DNGA150408TH4	●					4	12.7	4.76	0.8	5.16	2.0
NP-DNGA150412TH4	●					4	12.7	4.76	1.2	5.16	1.8
NP-DNGA150608TH4	●					4	12.7	6.35	0.8	5.16	2.0
NP-DNGA150612TH4	●					4	12.7	6.35	1.2	5.16	1.8
NP-DNGA110408GA2	●					2	9.525	4.76	0.8	3.81	2.0
NP-DNGA150402GA2	●					2	12.7	4.76	0.2	5.16	2.2
NP-DNGA150404GA2	●					2	12.7	4.76	0.4	5.16	2.1
NP-DNGA150408GA2	●					2	12.7	4.76	0.8	5.16	2.0
NP-DNGA150412GA2	●					2	12.7	4.76	1.2	5.16	1.8
NP-DNGA150604GA2	●					2	12.7	6.35	0.4	5.16	2.1
NP-DNGA150608GA2	●					2	12.7	6.35	0.8	5.16	2.0
NP-DNGA150612GA2	●					2	12.7	6.35	1.2	5.16	1.8
NP-DNGA150402GS2	●					2	12.7	4.76	0.2	5.16	2.2
NP-DNGA150404GS2	●					2	12.7	4.76	0.4	5.16	2.1
NP-DNGA150408GS2	●					2	12.7	4.76	0.8	5.16	2.0
NP-DNGA150412GS2	●					2	12.7	4.76	1.2	5.16	1.8
NP-DNGA150604GS2	●					2	12.7	6.35	0.4	5.16	2.1
NP-DNGA150608GS2	●					2	12.7	6.35	0.8	5.16	2.0
NP-DNGA150612GS2	●					2	12.7	6.35	1.2	5.16	1.8
NP-DNGA150404GH2	●●					2	12.7	4.76	0.4	5.16	2.1
NP-DNGA150408GH2	●●					2	12.7	4.76	0.8	5.16	2.0
NP-DNGA150412GH2	●●					2	12.7	4.76	1.2	5.16	1.8
NP-DNGA150604GH2	●●					2	12.7	6.35	0.4	5.16	2.1
NP-DNGA150608GH2	●●					2	12.7	6.35	0.8	5.16	2.0
NP-DNGA150612GH2	●●					2	12.7	6.35	1.2	5.16	1.8
NP-DNGA150402FS2	●					2	12.7	4.76	0.2	5.16	2.2
NP-DNGA150404FS2	●					2	12.7	4.76	0.4	5.16	2.1
NP-DNGA150408FS2	●					2	12.7	4.76	0.8	5.16	2.0
NP-DNGA150412FS2	●					2	12.7	4.76	1.2	5.16	1.8
NP-DNGA150604FS2	●					2	12.7	6.35	0.4	5.16	2.1
NP-DNGA150608FS2	●					2	12.7	6.35	0.8	5.16	2.0
NP-DNGA150612FS2	●					2	12.7	6.35	1.2	5.16	1.8
NP-DNGA150404VA2	●					2	12.7	4.76	0.4	5.16	2.1
NP-DNGA150408VA2	●					2	12.7	4.76	0.8	5.16	2.0
NP-DNGA150412VA2	●					2	12.7	4.76	1.2	5.16	1.8
NP-DNGA150604VA2	●					2	12.7	6.35	0.4	5.16	2.1
NP-DNGA150608VA2	●					2	12.7	6.35	0.8	5.16	2.0
NP-DNGA150612VA2	●					2	12.7	6.35	1.2	5.16	1.8
NP-DNGA150404TA2	●					2	12.7	4.76	0.4	5.16	2.1
NP-DNGA150408TA2	●					2	12.7	4.76	0.8	5.16	2.0
NP-DNGA150412TA2	●					2	12.7	4.76	1.2	5.16	1.8
NP-DNGA150604TA2	●					2	12.7	6.35	0.4	5.16	2.1
NP-DNGA150608TA2	●					2	12.7	6.35	0.8	5.16	2.0
NP-DNGA150612TA2	●					2	12.7	6.35	1.2	5.16	1.8

BC8200 Series NEW

(mm)

Order Number	Coated CBN					Cutting Edges	IC	S	RE	D1	LE
	BC8210	BC8220									
NP-DNGA150404TS2	●					2	12.7	4.76	0.4	5.16	2.1
NP-DNGA150408TS2	●					2	12.7	4.76	0.8	5.16	2.0
NP-DNGA150412TS2	●					2	12.7	4.76	1.2	5.16	1.8
NP-DNGA150604TS2	●					2	12.7	6.35	0.4	5.16	2.1
NP-DNGA150608TS2	●					2	12.7	6.35	0.8	5.16	2.0
NP-DNGA150612TS2	●					2	12.7	6.35	1.2	5.16	1.8
NP-DNGA150408TH2	●					2	12.7	4.76	0.8	5.16	2.0
NP-DNGA150412TH2	●					2	12.7	4.76	1.2	5.16	1.8
NP-DNGA150608TH2	●					2	12.7	6.35	0.8	5.16	2.0
NP-DNGA150612TH2	●					2	12.7	6.35	1.2	5.16	1.8
NP-DNGA150404GAWS2JR	●					2	12.7	4.76	0.4	5.16	1.8
NP-DNGA150404GAWS2JL	●					2	12.7	4.76	0.4	5.16	1.8
NP-DNGA150408GAWS2JR	●					2	12.7	4.76	0.8	5.16	1.7
NP-DNGA150408GAWS2JL	●					2	12.7	4.76	0.8	5.16	1.7
NP-DNGA150604GAWS2JR	●					2	12.7	6.35	0.4	5.16	1.8
NP-DNGA150604GAWS2JL	●					2	12.7	6.35	0.4	5.16	1.8
NP-DNGA150608GAWS2JR	●					2	12.7	6.35	0.8	5.16	1.7
NP-DNGA150608GAWS2JL	●					2	12.7	6.35	0.8	5.16	1.7
NP-DNGA150404GSWS2JR	●					2	12.7	4.76	0.4	5.16	1.8
NP-DNGA150404GSWS2JL	●					2	12.7	4.76	0.4	5.16	1.8
NP-DNGA150408GSWS2JR	●					2	12.7	4.76	0.8	5.16	1.7
NP-DNGA150408GSWS2JL	●					2	12.7	4.76	0.8	5.16	1.7
NP-DNGA150604GSWS2JR	●					2	12.7	6.35	0.4	5.16	1.8
NP-DNGA150604GSWS2JL	●					2	12.7	6.35	0.4	5.16	1.8
NP-DNGA150608GSWS2JR	●					2	12.7	6.35	0.8	5.16	1.7
NP-DNGA150608GSWS2JL	●					2	12.7	6.35	0.8	5.16	1.7
BF-DNGM150408TAWS2	●					2	12.7	4.76	0.8	5.16	2.4
BF-DNGM150412TAWS2	●					2	12.7	4.76	1.2	5.16	2.6
BF-DNGM150404TS2	●					2	12.7	4.76	0.4	5.16	2.1
BF-DNGM150408TS2	●					2	12.7	4.76	0.8	5.16	2.0
BF-DNGM150412TS2	●					2	12.7	4.76	1.2	5.16	1.8
BF-DNGM150408TSWS2	●					2	12.7	4.76	0.8	5.16	2.4
BF-DNGM150412TSWS2	●					2	12.7	4.76	1.2	5.16	2.6
BM-DNGM150404TA2	●					2	12.7	4.76	0.4	5.16	2.1
BM-DNGM150408TA2	●					2	12.7	4.76	0.8	5.16	2.0
BM-DNGM150412TA2	●					2	12.7	4.76	1.2	5.16	1.8
NEW BR-DNGM150404TA2	●					2	12.7	4.76	0.4	5.16	2.1
NEW BR-DNGM150408TA2	●					2	12.7	4.76	0.8	5.16	2.0
NEW BR-DNGM150412TA2	●					2	12.7	4.76	1.2	5.16	1.8
NEW BR-DNGM150604TA2	●					2	12.7	6.35	0.4	5.16	2.1
NEW BR-DNGM150608TA2	●					2	12.7	6.35	0.8	5.16	2.0
NEW BR-DNGM150612TA2	●					2	12.7	6.35	1.2	5.16	1.8

● : Inventory maintained in Japan. (1 insert in one case)

Negative Inserts (With Hole)

G Class

SNGA

NEW PETIT CUT

NP_002



2 corner

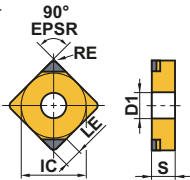

(mm)

Order Number	Coated CBN					Cutting Edges	IC	S	RE	D1	LE
	BC8210	BC8220									
NP-SNGA120408GA2		●				2	12.7	4.76	0.8	5.16	2.2
NP-SNGA120412GA2		●				2	12.7	4.76	1.2	5.16	2.5

Negative Inserts (With Hole)

G Class

WNGA

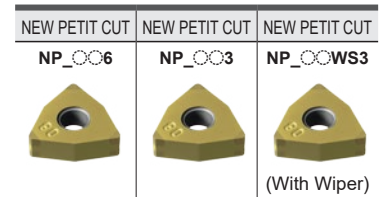

6 corner

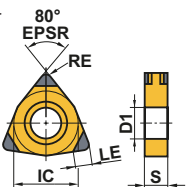

3 corner

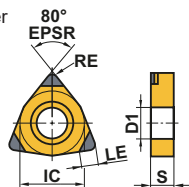

(mm)

Order Number	Coated CBN					Cutting Edges	IC	S	RE	D1	LE
	BC8210	BC8220									
NP-WNGA080408GS6	●					6	12.7	4.76	0.8	5.16	2.0
NP-WNGA080408FS6	●					6	12.7	4.76	0.8	5.16	2.0
NP-WNGA080408TS6	●					6	12.7	4.76	0.8	5.16	2.0
NP-WNGA080408GA3		●				3	12.7	4.76	0.8	5.16	2.0
NP-WNGA080408GS3	●					3	12.7	4.76	0.8	5.16	2.0
NP-WNGA080408FS3	●					3	12.7	4.76	0.8	5.16	2.0
NP-WNGA080408TA3		●				3	12.7	4.76	0.8	5.16	2.0
NP-WNGA080408TS3	●					3	12.7	4.76	0.8	5.16	2.0
NP-WNGA080408GSWS3	●					3	12.7	4.76	0.8	5.16	2.0

BC8200 Series

NEW

Negative Inserts (With Hole)

G Class

TNGA

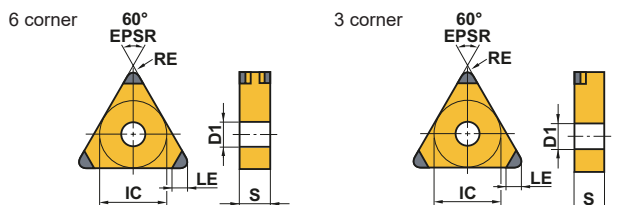
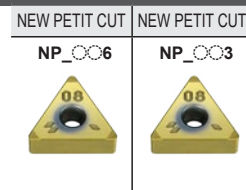

(mm)

Order Number	Coated CBN						Cutting Edges	IC	S	RE	D1	LE
	BC8210	BC8220										
NP-TNGA160404GA6	●						6	9.525	4.76	0.4	3.81	1.6
NP-TNGA160408GA6	●						6	9.525	4.76	0.8	3.81	1.7
NP-TNGA160412GA6	●						6	9.525	4.76	1.2	3.81	1.9
NP-TNGA160404GS6	●						6	9.525	4.76	0.4	3.81	1.6
NP-TNGA160408GS6	●						6	9.525	4.76	0.8	3.81	1.7
NP-TNGA160412GS6	●						6	9.525	4.76	1.2	3.81	1.9
NP-TNGA160404GH6	●						6	9.525	4.76	0.4	3.81	1.6
NP-TNGA160408GH6	●						6	9.525	4.76	0.8	3.81	1.7
NP-TNGA160412GH6	●						6	9.525	4.76	1.2	3.81	1.9
NP-TNGA160404FS6	●						6	9.525	4.76	0.4	3.81	1.6
NP-TNGA160408FS6	●						6	9.525	4.76	0.8	3.81	1.7
NP-TNGA160412FS6	●						6	9.525	4.76	1.2	3.81	1.9
NP-TNGA160404VA6	●						6	9.525	4.76	0.4	3.81	1.6
NP-TNGA160408VA6	●						6	9.525	4.76	0.8	3.81	1.7
NP-TNGA160412VA6	●						6	9.525	4.76	1.2	3.81	1.9
NP-TNGA160404TA6	●						6	9.525	4.76	0.4	3.81	1.6
NP-TNGA160408TA6	●						6	9.525	4.76	0.8	3.81	1.7
NP-TNGA160412TA6	●						6	9.525	4.76	1.2	3.81	1.9
NP-TNGA160404TS6	●						6	9.525	4.76	0.4	3.81	1.6
NP-TNGA160408TS6	●						6	9.525	4.76	0.8	3.81	1.7
NP-TNGA160412TS6	●						6	9.525	4.76	1.2	3.81	1.9
NP-TNGA160408TH6	●						6	9.525	4.76	0.8	3.81	1.7
NP-TNGA160412TH6	●						6	9.525	4.76	1.2	3.81	1.9
NP-TNGA160402GA3	●						3	9.525	4.76	0.2	3.81	1.5
NP-TNGA160404GA3	●						3	9.525	4.76	0.4	3.81	1.6
NP-TNGA160408GA3	●						3	9.525	4.76	0.8	3.81	1.7
NP-TNGA160412GA3	●						3	9.525	4.76	1.2	3.81	1.9
NP-TNGA160402GS3	●						3	9.525	4.76	0.2	3.81	1.5
NP-TNGA160404GS3	●						3	9.525	4.76	0.4	3.81	1.6
NP-TNGA160408GS3	●						3	9.525	4.76	0.8	3.81	1.7
NP-TNGA160412GS3	●						3	9.525	4.76	1.2	3.81	1.9
NP-TNGA160404GH3	●						3	9.525	4.76	0.4	3.81	1.6
NP-TNGA160408GH3	●						3	9.525	4.76	0.8	3.81	1.7
NP-TNGA160412GH3	●						3	9.525	4.76	1.2	3.81	1.9
NP-TNGA160402FS3	●						3	9.525	4.76	0.2	3.81	1.5
NP-TNGA160404FS3	●						3	9.525	4.76	0.4	3.81	1.6
NP-TNGA160408FS3	●						3	9.525	4.76	0.8	3.81	1.7
NP-TNGA160412FS3	●						3	9.525	4.76	1.2	3.81	1.9

● : Inventory maintained in Japan. (1 insert in one case)

(mm)

Order Number	Coated CBN						Cutting Edges	IC	S	RE	D1	LE
	BC8210	BC8220										
NP-TNGA160404VA3	●						3	9.525	4.76	0.4	3.81	1.6
NP-TNGA160408VA3	●						3	9.525	4.76	0.8	3.81	1.7
NP-TNGA160412VA3	●						3	9.525	4.76	1.2	3.81	1.9
NP-TNGA160404TA3	●						3	9.525	4.76	0.4	3.81	1.6
NP-TNGA160408TA3	●						3	9.525	4.76	0.8	3.81	1.7
NP-TNGA160412TA3	●						3	9.525	4.76	1.2	3.81	1.9
NP-TNGA160404TS3	●						3	9.525	4.76	0.4	3.81	1.6
NP-TNGA160408TS3	●						3	9.525	4.76	0.8	3.81	1.7
NP-TNGA160412TS3	●						3	9.525	4.76	1.2	3.81	1.9
NP-TNGA160408TH3	●						3	9.525	4.76	0.8	3.81	1.7
NP-TNGA160412TH3	●						3	9.525	4.76	1.2	3.81	1.9

BC8200 Series NEW

Negative Inserts (With Hole)

G Class

VNGA

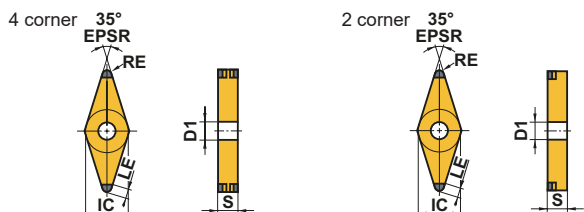
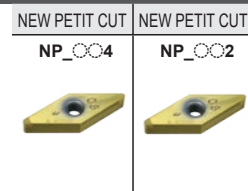

(mm)

Order Number	Coated CBN					Cutting Edges	IC	S	RE	D1	LE
	BC8210	BC8220									
NP-VNGA160404GA4	●					4	9.525	4.76	0.4	3.81	2.5
NP-VNGA160408GA4	●					4	9.525	4.76	0.8	3.81	2.0
NP-VNGA160412GA4	●					4	9.525	4.76	1.2	3.81	1.5
NP-VNGA160404GS4	●					4	9.525	4.76	0.4	3.81	2.5
NP-VNGA160408GS4	●					4	9.525	4.76	0.8	3.81	2.0
NP-VNGA160412GS4	●					4	9.525	4.76	1.2	3.81	1.5
NP-VNGA160404GH4	●					4	9.525	4.76	0.4	3.81	2.5
NP-VNGA160408GH4	●					4	9.525	4.76	0.8	3.81	2.0
NP-VNGA160404FS4	●					4	9.525	4.76	0.4	3.81	2.5
NP-VNGA160408FS4	●					4	9.525	4.76	0.8	3.81	2.0
NP-VNGA160404VA4	●					4	9.525	4.76	0.4	3.81	2.5
NP-VNGA160408VA4	●					4	9.525	4.76	0.8	3.81	2.0
NP-VNGA160412VA4	●					4	9.525	4.76	1.2	3.81	1.5
NP-VNGA160404TA4	●					4	9.525	4.76	0.4	3.81	2.5
NP-VNGA160408TA4	●					4	9.525	4.76	0.8	3.81	2.0
NP-VNGA160404TS4	●					4	9.525	4.76	0.4	3.81	2.5
NP-VNGA160408TS4	●					4	9.525	4.76	0.8	3.81	2.0
NP-VNGA160404TH4	●					4	9.525	4.76	0.4	3.81	2.5
NP-VNGA160408TH4	●					4	9.525	4.76	0.8	3.81	2.0
NP-VNGA160402GA2	●					2	9.525	4.76	0.2	3.81	2.5
NP-VNGA160404GA2	●					2	9.525	4.76	0.4	3.81	2.5
NP-VNGA160408GA2	●					2	9.525	4.76	0.8	3.81	2.0
NP-VNGA160412GA2	●					2	9.525	4.76	1.2	3.81	1.5
NP-VNGA160402GS2	●					2	9.525	4.76	0.2	3.81	2.5
NP-VNGA160404GS2	●					2	9.525	4.76	0.4	3.81	2.5
NP-VNGA160408GS2	●					2	9.525	4.76	0.8	3.81	2.0
NP-VNGA160412GS2	●					2	9.525	4.76	1.2	3.81	1.5
NP-VNGA160404GH2	●					2	9.525	4.76	0.4	3.81	2.5
NP-VNGA160408GH2	●					2	9.525	4.76	0.8	3.81	2.0
NP-VNGA160402FS2	●					2	9.525	4.76	0.2	3.81	2.5
NP-VNGA160404FS2	●					2	9.525	4.76	0.4	3.81	2.5
NP-VNGA160408FS2	●					2	9.525	4.76	0.8	3.81	2.0
NP-VNGA160404VA2	●					2	9.525	4.76	0.4	3.81	2.5
NP-VNGA160408VA2	●					2	9.525	4.76	0.8	3.81	2.0
NP-VNGA160412VA2	●					2	9.525	4.76	1.2	3.81	1.5
NP-VNGA160404TA2	●					2	9.525	4.76	0.4	3.81	2.5
NP-VNGA160408TA2	●					2	9.525	4.76	0.8	3.81	2.0
NP-VNGA160404TS2	●					2	9.525	4.76	0.4	3.81	2.5
NP-VNGA160408TS2	●					2	9.525	4.76	0.8	3.81	2.0
NP-VNGA160404TH2	●					2	9.525	4.76	0.4	3.81	2.5
NP-VNGA160408TH2	●					2	9.525	4.76	0.8	3.81	2.0

● : Inventory maintained in Japan. (1 insert in one case)

Positive Inserts (With Hole)

G Class
CCGW 7°, CCGT 7°,
CPGB 11°

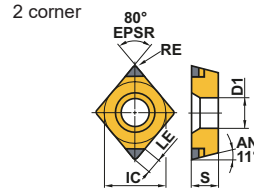
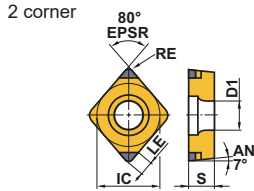
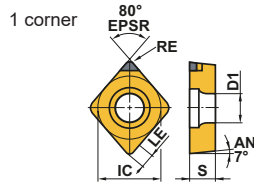

NEW PETIT CUT	NEW PETIT CUT	NEW PETIT CUT	NEW PETIT CUT
NP_002	NP_00W02	BM_	NP
	(With Wiper)	(With Breaker)	(Non-ISO) *

(mm)

Order Number	Coated CBN					Cutting Edges	IC	S	RE	D1	LE
	BC8210	BC8220									
NP-CCGW060202GA2	●					2	6.35	2.38	0.2	2.8	1.7
NP-CCGW060204GA2	●					2	6.35	2.38	0.4	2.8	1.8
NP-CCGW060208GA2	●					2	6.35	2.38	0.8	2.8	2.0
NP-CCGW09T302GA2	●					2	9.525	3.97	0.2	4.4	1.7
NP-CCGW09T304GA2	●					2	9.525	3.97	0.4	4.4	1.8
NP-CCGW09T308GA2	●					2	9.525	3.97	0.8	4.4	2.0
NP-CCGW060202GS2	●					2	6.35	2.38	0.2	2.8	1.7
NP-CCGW060204GS2	●					2	6.35	2.38	0.4	2.8	1.8
NP-CCGW060208GS2	●					2	6.35	2.38	0.8	2.8	2.0
NP-CCGW09T302GS2	●					2	9.525	3.97	0.2	4.4	1.7
NP-CCGW09T304GS2	●					2	9.525	3.97	0.4	4.4	1.8
NP-CCGW09T308GS2	●					2	9.525	3.97	0.8	4.4	2.0
NP-CCGW060202FS2	●					2	6.35	2.38	0.2	2.8	1.7
NP-CCGW060204FS2	●					2	6.35	2.38	0.4	2.8	1.8
NP-CCGW060208FS2	●					2	6.35	2.38	0.8	2.8	2.0
NP-CCGW09T302FS2	●					2	9.525	3.97	0.2	4.4	1.7
NP-CCGW09T304FS2	●					2	9.525	3.97	0.4	4.4	1.8
NP-CCGW09T308FS2	●					2	9.525	3.97	0.8	4.4	2.0
NP-CCGW09T304VA2	●					2	9.525	3.97	0.4	4.4	1.8
NP-CCGW09T308VA2	●					2	9.525	3.97	0.8	4.4	2.0
NP-CCGW09T304TA2	●					2	9.525	3.97	0.4	4.4	1.8
NP-CCGW09T308TA2	●					2	9.525	3.97	0.8	4.4	2.0
NP-CCGW09T304FSWS2	●					2	9.525	3.97	0.4	4.4	1.8
NP-CCGW09T308FSWS2	●					2	9.525	3.97	0.8	4.4	2.0
NP-CCGW09T304GAWS2	●					2	9.525	3.97	0.4	4.4	1.8
NP-CCGW09T308GAWS2	●					2	9.525	3.97	0.8	4.4	2.0
NP-CCGW09T304GSWS2	●					2	9.525	3.97	0.4	4.4	1.8
NP-CCGW09T308GSWS2	●					2	9.525	3.97	0.8	4.4	2.0
BF-CCGT09T304TS2	●					2	9.525	3.97	0.4	4.4	1.8
BF-CCGT09T308TS2	●					2	9.525	3.97	0.8	4.4	2.0
BM-CCGT09T304TA2	●					2	9.525	3.97	0.4	4.4	1.8
BM-CCGT09T308TA2	●					2	9.525	3.97	0.8	4.4	2.0
NP-CCGW03S102FS	●					1	3.57*	1.39	0.2	2.0	1.1
NP-CCGW03S104FS	●					1	3.57*	1.39	0.4	2.0	1.0
NP-CCGW04T002FS	●					1	4.37*	1.79	0.2	2.4	1.5
NP-CCGW04T004FS	●					1	4.37*	1.79	0.4	2.4	1.4

* Diameter of inscribed circle is non-ISO standard. (For SCLC type)

BC8200 Series

NEW

(mm)

Order Number	Coated CBN					Cutting Edges	IC	S	RE	D1	LE
	BC8210	BC8220									
NP-CPGB080204GA2	●					2	7.94	2.38	0.4	3.5	1.8
NP-CPGB080208GA2	●					2	7.94	2.38	0.8	3.5	2.0
NP-CPGB080212GA2	●					2	7.94	2.38	1.2	3.5	2.2
NP-CPGB090302GA2	●					2	9.525	3.18	0.2	4.5	1.7
NP-CPGB090304GA2	●					2	9.525	3.18	0.4	4.5	1.8
NP-CPGB090308GA2	●					2	9.525	3.18	0.8	4.5	2.0
NP-CPGB090312GA2	●					2	9.525	3.18	1.2	4.5	2.2
NP-CPGB080204GS2	●					2	7.94	2.38	0.4	3.5	1.8
NP-CPGB080208GS2	●					2	7.94	2.38	0.8	3.5	2.0
NP-CPGB090302GS2	●					2	9.525	3.18	0.2	4.5	1.7
NP-CPGB090304GS2	●					2	9.525	3.18	0.4	4.5	1.8
NP-CPGB090308GS2	●					2	9.525	3.18	0.8	4.5	2.0
NP-CPGB090304VA2	●					2	9.525	3.18	0.4	4.5	1.8
NP-CPGB090308VA2	●					2	9.525	3.18	0.8	4.5	2.0
NP-CPGB090312VA2	●					2	9.525	3.18	1.2	4.5	2.2
NP-CPGB090304TA2	●					2	9.525	3.18	0.4	4.5	1.8
NP-CPGB090308TA2	●					2	9.525	3.18	0.8	4.5	2.0
NP-CPGB090312TA2	●					2	9.525	3.18	1.2	4.5	2.2

● : Inventory maintained in Japan. (1 insert in one case)

Positive Inserts (With Hole)

G Class

DCGW 7°, DCGT 7°

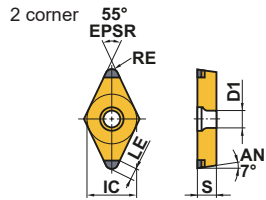
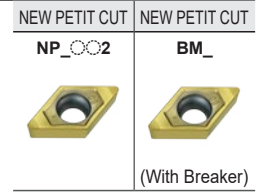

Order Number	Coated CBN						Cutting Edges	IC	S	RE	D1	LE
	BC8210	BC8220										
NP-DCGW070202GA2	●						2	6.35	2.38	0.2	2.8	2.2
NP-DCGW070204GA2	●						2	6.35	2.38	0.4	2.8	2.1
NP-DCGW070208GA2	●						2	6.35	2.38	0.8	2.8	2.0
NP-DCGW11T302GA2	●						2	9.525	3.97	0.2	4.4	2.2
NP-DCGW11T304GA2	●						2	9.525	3.97	0.4	4.4	2.1
NP-DCGW11T308GA2	●						2	9.525	3.97	0.8	4.4	2.0
NP-DCGW070202GS2	●						2	6.35	2.38	0.2	2.8	2.2
NP-DCGW070204GS2	●						2	6.35	2.38	0.4	2.8	2.1
NP-DCGW070208GS2	●						2	6.35	2.38	0.8	2.8	2.0
NP-DCGW11T302GS2	●						2	9.525	3.97	0.2	4.4	2.2
NP-DCGW11T304GS2	●						2	9.525	3.97	0.4	4.4	2.1
NP-DCGW11T308GS2	●						2	9.525	3.97	0.8	4.4	2.0
NP-DCGW070202FS2	●						2	6.35	2.38	0.2	2.8	2.2
NP-DCGW070204FS2	●						2	6.35	2.38	0.4	2.8	2.1
NP-DCGW070208FS2	●						2	6.35	2.38	0.8	2.8	2.0
NP-DCGW11T302FS2	●						2	9.525	3.97	0.2	4.4	2.2
NP-DCGW11T304FS2	●						2	9.525	3.97	0.4	4.4	2.1
NP-DCGW11T308FS2	●						2	9.525	3.97	0.8	4.4	2.0
NP-DCGW11T304VA2	●						2	9.525	3.97	0.4	4.4	2.1
NP-DCGW11T308VA2	●						2	9.525	3.97	0.8	4.4	2.0
NP-DCGW11T304TA2	●						2	9.525	3.97	0.4	4.4	2.1
NP-DCGW11T308TA2	●						2	9.525	3.97	0.8	4.4	2.0
BF-DCGT11T304TS2	●						2	9.525	3.97	0.4	4.4	2.1
BF-DCGT11T308TS2	●						2	9.525	3.97	0.8	4.4	2.0
BM-DCGT11T304TA2	●						2	9.525	3.97	0.4	4.4	2.1
BM-DCGT11T308TA2	●						2	9.525	3.97	0.8	4.4	2.0

BC8200 Series

NEW

Positive Inserts (With Hole)

G Class

TPGB 11°

NEW PETIT CUT

NP_003



3 corner

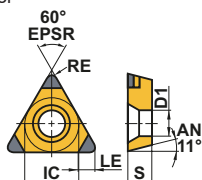

(mm)

Order Number	Coated CBN						Cutting Edges	IC	S	RE	D1	LE
	BC8210	BC8220										
NP-TPGB090204GA3	●						3	5.56	2.38	0.4	2.9	1.6
NP-TPGB090208GA3	●						3	5.56	2.38	0.8	2.9	1.7
NP-TPGB110302GA3	●						3	6.35	3.18	0.2	3.4	1.5
NP-TPGB110304GA3	●						3	6.35	3.18	0.4	3.4	1.6
NP-TPGB110308GA3	●						3	6.35	3.18	0.8	3.4	1.7
NP-TPGB160304GA3	●						3	9.525	3.18	0.4	4.4	1.6
NP-TPGB160308GA3	●						3	9.525	3.18	0.8	4.4	1.7
NP-TPGB080204GS3	●						3	4.76	2.38	0.4	2.4	1.6
NP-TPGB080208GS3	●						3	4.76	2.38	0.8	2.4	1.7
NP-TPGB090204GS3	●						3	5.56	2.38	0.4	2.9	1.6
NP-TPGB090208GS3	●						3	5.56	2.38	0.8	2.9	1.7
NP-TPGB110302GS3	●						3	6.35	3.18	0.2	3.4	1.5
NP-TPGB110304GS3	●						3	6.35	3.18	0.4	3.4	1.6
NP-TPGB110308GS3	●						3	6.35	3.18	0.8	3.4	1.7
NP-TPGB160304GS3	●						3	9.525	3.18	0.4	4.4	1.6
NP-TPGB160308GS3	●						3	9.525	3.18	0.8	4.4	1.7
NP-TPGB110302FS3	●						3	6.35	3.18	0.2	3.4	1.5
NP-TPGB110304FS3	●						3	6.35	3.18	0.4	3.4	1.6
NP-TPGB110308FS3	●						3	6.35	3.18	0.8	3.4	1.7
NP-TPGB110304VA3	●						3	6.35	3.18	0.4	3.4	1.6
NP-TPGB110308VA3	●						3	6.35	3.18	0.8	3.4	1.7
NP-TPGB110304TA3	●						3	6.35	3.18	0.4	3.4	1.6
NP-TPGB110308TA3	●						3	6.35	3.18	0.8	3.4	1.7

● : Inventory maintained in Japan. (1 insert in one case)

Positive Inserts (With Hole)

G Class

VBGW 5°, VCGW 7°

NEW PETIT CUT

NP_002

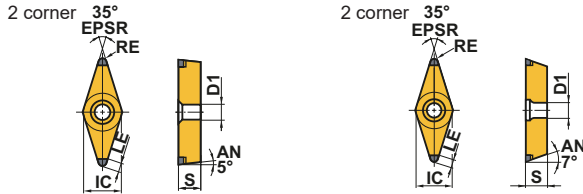

(mm)

Order Number	Coated CBN					Cutting Edges	IC	S	RE	D1	LE
	BC8210	BC8220									
NP-VBGW110302GA2		●				2	6.35	3.18	0.2	2.85	2.5
NP-VBGW110304GA2		●				2	6.35	3.18	0.4	2.85	2.5
NP-VBGW110308GA2		●				2	6.35	3.18	0.8	2.85	2.0
NP-VBGW160402GA2		●				2	9.525	4.76	0.2	4.43	2.5
NP-VBGW160404GA2		●				2	9.525	4.76	0.4	4.43	2.5
NP-VBGW160408GA2		●				2	9.525	4.76	0.8	4.43	2.0
NP-VBGW110302GS2	●					2	6.35	3.18	0.2	2.85	2.5
NP-VBGW110304GS2	●					2	6.35	3.18	0.4	2.85	2.5
NP-VBGW110308GS2	●					2	6.35	3.18	0.8	2.85	2.0
NP-VBGW160402GS2	●					2	9.525	4.76	0.2	4.43	2.5
NP-VBGW160404GS2	●					2	9.525	4.76	0.4	4.43	2.5
NP-VBGW160408GS2	●					2	9.525	4.76	0.8	4.43	2.0
NP-VBGW110302FS2	●					2	6.35	3.18	0.2	2.85	2.5
NP-VBGW110304FS2	●					2	6.35	3.18	0.4	2.85	2.5
NP-VBGW110308FS2	●					2	6.35	3.18	0.8	2.85	2.0
NP-VBGW160402FS2	●					2	9.525	4.76	0.2	4.43	2.5
NP-VBGW160404VA2		●				2	9.525	4.76	0.4	4.43	2.5
NP-VBGW160408VA2		●				2	9.525	4.76	0.8	4.43	2.0
NP-VBGW160404TA2		●				2	9.525	4.76	0.4	4.43	2.5
NP-VBGW160408TA2		●				2	9.525	4.76	0.8	4.43	2.0
NP-VCGW160404GA2		●				2	9.525	4.76	0.4	4.4	2.5
NP-VCGW160408GA2		●				2	9.525	4.76	0.8	4.4	2.0
NP-VCGW160404GS2	●					2	9.525	4.76	0.4	4.4	2.5
NP-VCGW160408GS2	●					2	9.525	4.76	0.8	4.4	2.0
NP-VCGW160404VA2		●				2	9.525	4.76	0.4	4.4	2.5
NP-VCGW160408VA2		●				2	9.525	4.76	0.8	4.4	2.0
NP-VCGW160404TA2		●				2	9.525	4.76	0.4	4.4	2.5
NP-VCGW160408TA2		●				2	9.525	4.76	0.8	4.4	2.0

BC8210 For Continuous and Light Interrupted Cutting

Comparison of Continuous Cutting : SCr420 (60HRC)

BC8210 reduces flank wear and maintains a good finished surface.

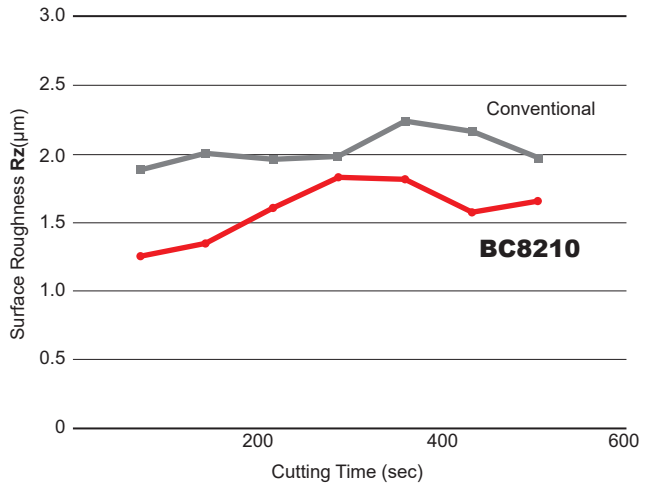
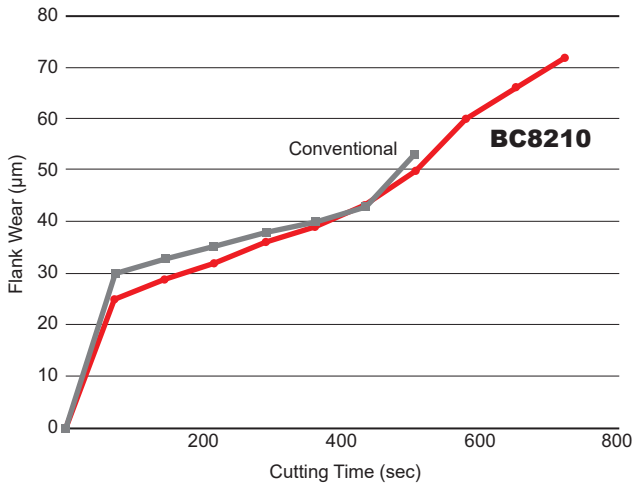

<Cutting Conditions>
 Workpiece Material : JIS SCr420 (60 HRC)
 Inserts : NP-CNGA120408GS2
 Cutting Speed : $v_c=200$ m/min
 Feed per Rev. : $f=0.1$ mm/rev
 Depth of Cut : $a_p=0.2$ mm
 Cutting Mode : Dry Cutting

Comparison of Light Interrupted Cutting : SCr420 (60HRC)

BC8210 provides excellent chipping resistance.

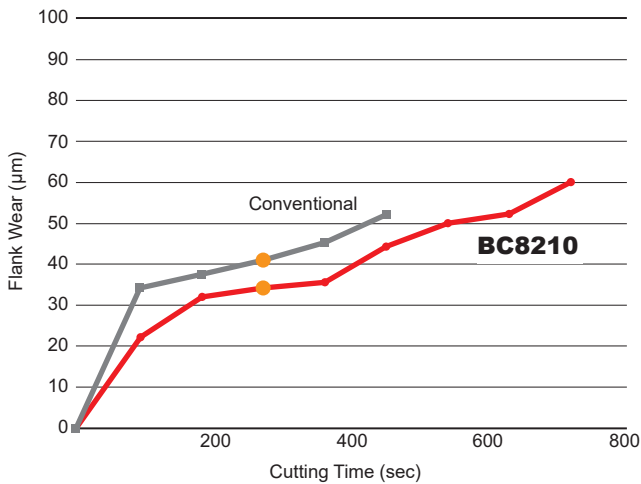

After machining 360 seconds

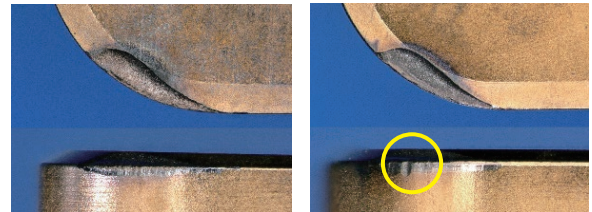

BC8210

Conventional Product is Chipping

<Cutting Conditions>
 Workpiece Material : JIS SCr420 (60 HRC)
 Inserts : NP-CNGA120408GS2
 Cutting Speed : $v_c=160$ m/min
 Feed per Rev. : $f=0.1$ mm/rev
 Depth of Cut : $a_p=0.2$ mm
 Cutting Mode : Dry Cutting

Recommended Cutting Conditions

Grade	Workpiece Material	Machining Methods	Cutting Speed v_c (m/min)					Feed per Rev. f (mm/rev)	Depth of Cut a_p (mm)	Cutting Mode
			100	150	200	250	300			
BC8210	Hardened Steels	Continuous Cutting	[Red bar from 150 to 250]					≤ 0.2	≤ 0.35	Dry, Wet
		Light Interrupted Cutting	[Red bar from 100 to 200]					≤ 0.2	≤ 0.35	Dry, Wet

BC8220 General Applications

Comparison of Fracture Resistant During Medium Interrupted Cutting : SCr420 (60HRC)

Stable cutting is achieved with excellent fracture resistance in medium interrupted cutting.

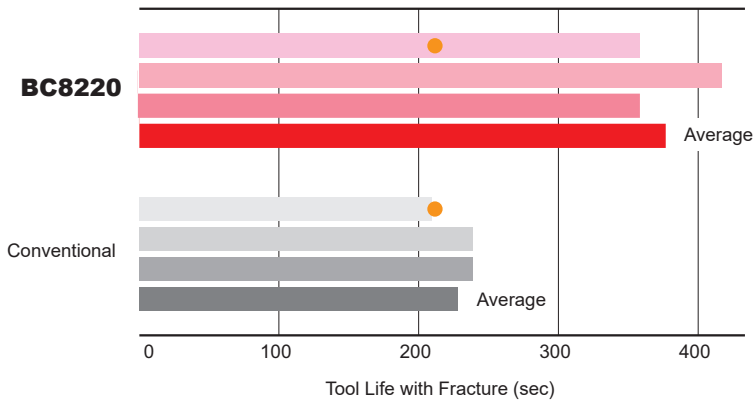

After machining 210 seconds

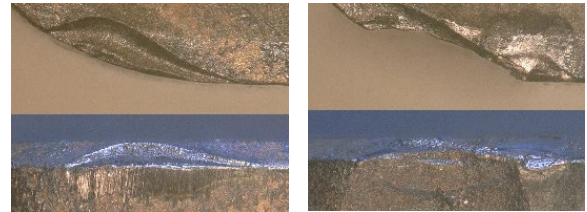

BC8220

Conventional

<Cutting Conditions>

Workpiece Material : JIS SCr420 (60 HRC)
 Inserts : NP-CNGA120408VA2
 Cutting Speed : vc=250m/min
 Feed per Rev. : f=0.15mm/rev
 Depth of Cut : ap=0.1mm
 Cutting Mode : Dry Cutting

Comparison of Fracture Resistant During Heavy Interrupted Cutting : SCr420 (60HRC)

Achieves excellent chipping resistance during heavy interrupted cutting.

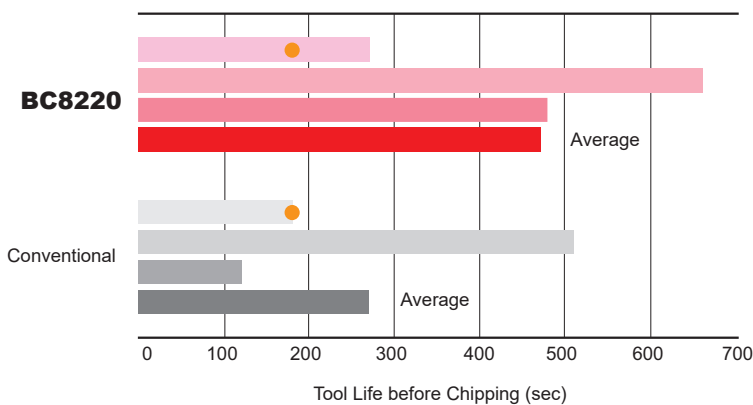

After machining 180 seconds

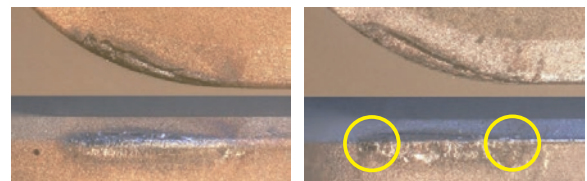

BC8220

Conventional Product is Chipping

<Cutting Conditions>



Workpiece Material : JIS SCr420 (60 HRC)
 Inserts : NP-CNGA120408VA2
 Cutting Speed : vc=200m/min
 Feed per Rev. : f=0.05mm/rev
 Depth of Cut : ap=0.1mm
 Cutting Mode : Wet Cutting



Recommended Cutting Conditions

Grade	Workpiece Material	Machining Methods	Cutting Speed vc (m/min)					Feed per Rev. f (mm/rev)	Depth of Cut ap (mm)	Cutting Mode
			100	150	200	250	300			
BC8220	Hardened Steels	Continuous Cutting	----- ----- ----- ----- -----					≤0.2	≤0.5	Dry, Wet
		Light to Medium Interrupted Cutting	----- ----- ----- ----- -----					≤0.2	≤0.3	Dry, Wet

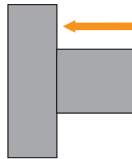

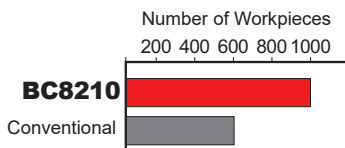
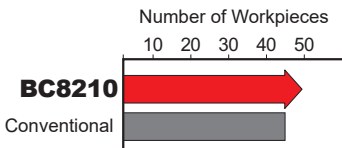

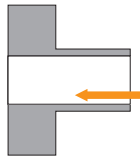
CBN Grade for Turning Hardened Steel

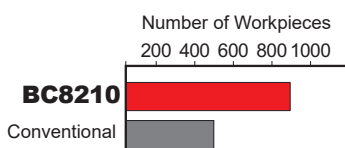
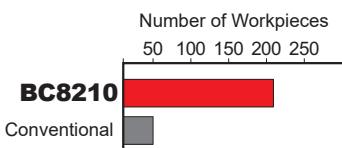

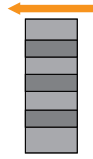

Examples of Usage

Insert		NP-CNGA120412GSWS2	NP-DCGW11T304GS2
Workpiece Material		Non-microalloyed Steel 	16MnCr5 
Component		Automobile Parts	Automobile Parts
Application		External Continuous Cutting	Internal Continuous Cutting
Cutting Conditions	Cutting Speed v_c (m/min)	260	240
	Feed per Rev. f (mm/rev)	0.20	0.08
	Depth of Cut a_p (mm)	0.15	0.20
Cutting Mode		Dry Cutting	Dry Cutting
Results		 <p>In continuous cutting, it was possible to maintain good surface finish and to achieve a tool life extension of 1.6 X or more compared to conventional products.</p>	 <p>The same tool life as continuous cutting was achieved. Good surface finish compared to conventional products was maintained.</p>

Insert		NP-CCGW09T308GS2	NP-CCGW09T304FS2
Workpiece Material		16MnCr5 	Alloy Steel 
Component		Automobile Parts	Automobile Parts
Application		Internal Continuous Cutting	Internal Continuous Cutting
Cutting Conditions	Cutting Speed v_c (m/min)	140	280
	Feed per Rev. f (mm/rev)	0.07	0.075
	Depth of Cut a_p (mm)	0.10	0.10
Cutting Mode		Dry Cutting	Dry Cutting
Results		 <p>By significantly suppressing the deterioration of the surface of the insert, tool life was extended during continuous cutting to 1.8 X longer than that of conventional products.</p>	 <p>Tool life is 4 X longer than that of conventional products during continuous cutting at high speeds.</p>

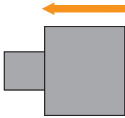
The application examples are from customers workpieces and can therefore differ from the recommended cutting conditions.





Insert		NP-TNGA160412TA3	NP-TNGA160420TA3
Workpiece Material		16MnCr5 	16MnCr5 
	Component	Automobile Parts	Automobile Parts
Application		Heavy Interrupted Boring	Heavy Interrupted Turning
Cutting Conditions	Cutting Speed v_c (m/min)	120	130
	Feed per Rev. f (mm/rev)	0.18	0.12
	Depth of Cut a_p (mm)	0.15-0.25	0.25
Cutting Mode		Dry Cutting	Dry Cutting
Results		<p>Number of Workpieces</p> <p>100 200 300 400 500 600</p> <p>BC8220 </p> <p>Conventional </p> <p>BC8220, which has excellent fracture resistance, has a tool life 1.5 times longer than that of conventional products.</p>	<p>Number of Workpieces</p> <p>100 200 300 400</p> <p>BC8220 </p> <p>Conventional </p> <p>BC8220, which has excellent fracture resistance, has a tool life 1.25 times longer than that of conventional products.</p>

Insert		NP-CNGA120404TA2	NP-DNGA110416GA2
Workpiece Material		SCM415 	S50C (58HRC) 
	Component	Automobile Parts	Automobile Parts
Application		External Continuous Cutting	External Continuous Cutting
Cutting Conditions	Cutting Speed v_c (m/min)	150	140
	Feed per Rev. f (mm/rev)	Rough 0.13 Finish 0.10	0.15
	Depth of Cut a_p (mm)	Rough 0.10 Finish 0.05	0.15
Cutting Mode		Dry Cutting	Dry Cutting
Results		<p>Number of Workpieces</p> <p>100 200 300 400</p> <p>BC8220 </p> <p>Conventional </p> <p>Tool life for continuous cutting is 2.5 times longer than that of conventional products.</p>	<p>Number of Workpieces</p> <p>100 200 300 400 500</p> <p>BC8220 </p> <p>Conventional </p> <p>Tool life for continuous cutting is 1.2 times longer than that of conventional products.</p>

The application examples are from customers workpieces and can therefore differ from the recommended cutting conditions.

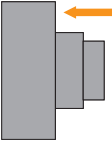
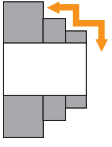
CBN Grade for Turning Hardened Steel

Examples of Usage

Insert		BR-CNGM120408TA2	BR-DNGM150408TA2
Workpiece Material		Steel (62-64HRC) 	SMnC420 (59-63HRC) 
Component		Gear	Gear
Application		External Continuous Cutting	External Continuous Interrupted Turning
Cutting Conditions	Cutting Speed v_c (m/min)	150-170	180
	Feed per Rev. f (mm/rev)	0.1-0.2	0.03→0.13
	Depth of Cut a_p (mm)	0.7	1.0-1.1
Cutting Mode		Dry Cutting	Dry Cutting
Results		<p>Number of Workpieces</p> <p>100 200 300 400 500</p> <p>BC8220 </p> <p>Conventional </p> <p>While conventional products can machine up to 300 pieces, BC8220 can machine up to 450 pieces.</p>	<p>Number of Workpieces</p> <p>50 100 150 200</p> <p>BC8220 </p> <p>Conventional </p> <p>The BR breaker removed the required material in one pass compared to a conventional product that took 4 passes. This gave the BR breaker a tool life 1.5 times greater than the conventional product.</p>

The application examples are from customers workpieces and can therefore differ from the recommended cutting conditions.

Memo

A series of horizontal dashed lines for writing, spanning the width of the page.

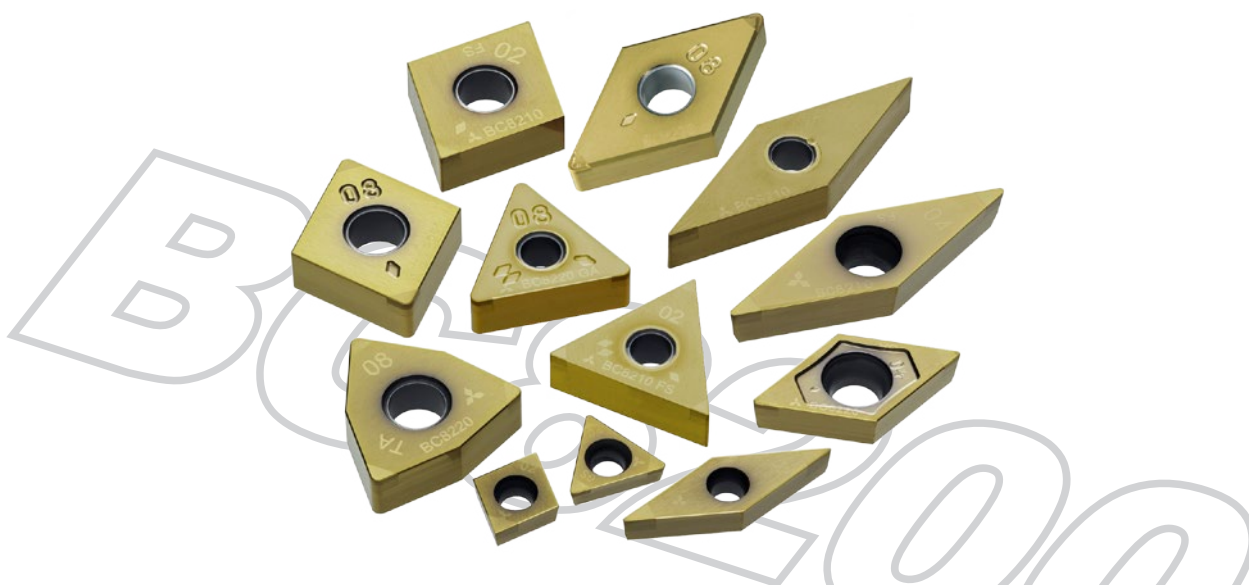

CBN Grade for Turning Hardened Steel

BC8200 Series

For Your Safety

●Don't handle inserts and chips without gloves. ●Please machine within the recommended application range and exchange expired tools with new ones in advance of breakage. ●Please use safety covers and wear safety glasses. ●When using compounded cutting oils, please take fire precautions. ●When attaching inserts or spare parts, please use only the correct wrench or driver. ●When using rotating tools, please make a trial run to check run-out, vibration and abnormal sounds etc.

 **MITSUBISHI MATERIALS CORPORATION**

MITSUBISHI MATERIALS CORPORATION

Overseas Sales Dept, Asian Region

KFC bldg., 8F, 1-6-1 Yokoami, Sumida-ku, Tokyo 130-0015, Japan
TEL +81-3-5819-8771 FAX +81-3-5819-8774

Overseas Sales Dept, European & American Region

KFC bldg., 8F, 1-6-1 Yokoami, Sumida-ku, Tokyo 130-0015, Japan
TEL +81-3-5819-8772 FAX +81-3-5819-8774

<http://www.mitsubishicarbide.com/en/>
(Tools specifications subject to change without notice.)